

Merkmale der erbrich Container-SystemeSeite Features of the erbrich Container-SystemsPage	IV - X II - X	
1/1 ContainerSeite 1/1 ContainersPage	1 - 4 1 - 4	
3/4 ContainerSeite 3/4 ContainersPage	5 - 8 5 - 8	
1/2 ContainerSeite 1/2 ContainersPage	9 - 12 9 - 12	
Entsorgungs ContainerSeite Removal ContainersPage	14 - 15 14 - 15	
Flach-ContainerSeite Flat ContainersPage	16 - 17 16 - 17	
Mini-ContainerSeite Mini ContainersPage	18 - 19 18 - 19	
Dental-ContainerSeite Dental ContainersPage	20 20	



Implantat-ContainerSeite	21
Implant ContainersPage	21



Siebkörbe für OptikenSeite	22
Wire Baskets for TelescopesPage	22



ZubehörSeite	23 - 27
AccessoriesPage	23 - 27



Bürstspender und BürstenSeite	28
Brush Dispenser and BrushesPage	28



WagenSeite	29
TrolleysPage	29



Sterilisier-Zangen und -KlammernSeite	30
Sterilizing Forceps and -ClampsPage	30

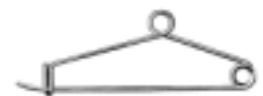

Instrumenten-Schalen und -GefäßeSeite	31 - 33
Instrument Trays and -JarsPage	31 - 33



NadelsterilisierdosenSeite	34
Needle Sterilizing BoxesPage	34





Sterilisations-Container
und Zubehör

Sterilizing Containers
and Accessories



Die Firma **erbrich - Instrumente GmbH** produziert und vertreibt seit nahezu 35 Jahren chirurgische Instrumente für alle Disziplinen sowie Instrumente für die Veterinärmedizin.

Auf Grund ihrer hervorragenden Qualität haben **erbrich - Instrumente** weltweit einen ausgezeichneten Ruf.

Neben der Qualität sind Innovation, Zuverlässigkeit sowie das komplette Programm Gründe, die **erbrich - Instrumente** zu einem wichtigen Partner in der Medizintechnik machen.

The **erbrich - Instruments GmbH**. produces and distributes since about 35 years surgical instruments for all branches as well as instruments for the veterinary medicine.

Due to their first class quality **erbrich - Instruments** have an excellent reputation worldwide.

In addition to the quality, the innovation, the reliability as well as the complete program are reasons to make **erbrich - Instruments** as an important partner in the medical technology

Wer Qualität sagt -
meint **erbrich**

Asking for quality -
means asking for **erbrich**

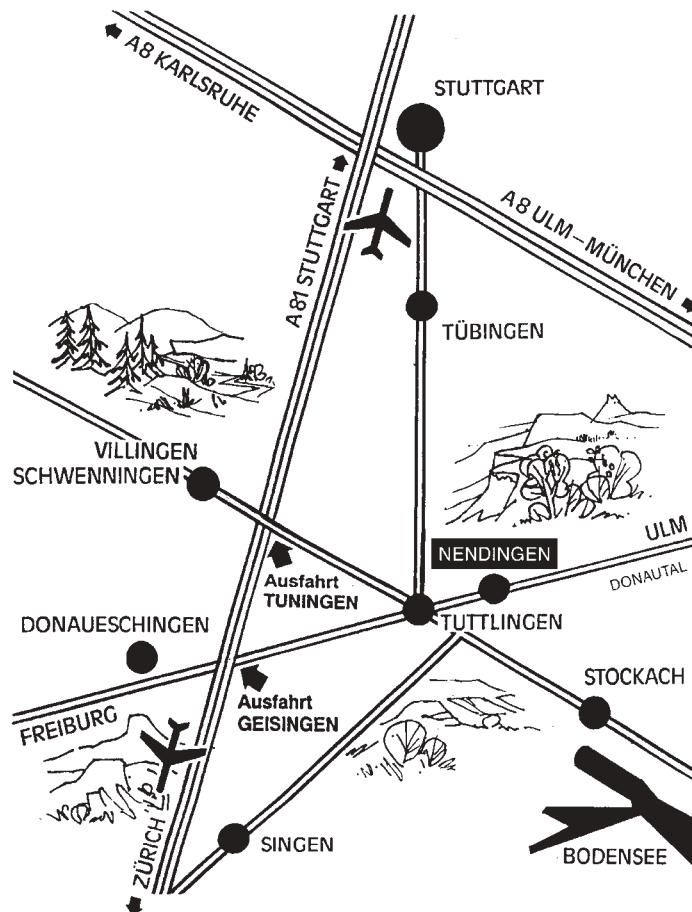

erbrich Container-Systeme

- Durch einheitliche Bauart sind alle Container und Siebkörbe raumsparend stapelbar.
- Langzeit-Sterillagerung.
- Die Verwendung von eloxiertem Aluminium gewährleistet beste Trocknungseigenschaften und Gewichtsreduzierung.
- Sicherer Transport und Aufbewahrung von Instrumenten.
- Kostenreduzierung durch lange Lebensdauer.
- Umfangreiches Zubehör ermöglicht einfache Anpassung an individuelle Instrumenten-Sätze und Bedürfnisse.
- Entsorgungs-Container schützen vor der Kontamination bei der Entsorgung.



erbrich Container-Systems

- All containers and wire baskets are standardized constructed, thus space and economic storage problems are eliminated.
- Long lasting sterilization.
- The anodized aluminium used ensures optimum drying properties and reduced weight.
- Safe transportation and storage of instruments.
- Cost reduction due to long service life.
- The great number of accessories allows easy adaption to individual instrument sets and requirements.
- Removal containers provide protection from contamination during removal.



Container mit Deckel-Perforation und **nicht** perforiertem Boden sind nach DIN 58946 Teil 6 'Betrieb von Groß-Sterilisatoren' für folgende Sterilisationen geeignet:

Fraktioniertes Strömungsverfahren

Bei diesem Verfahren wird die Luft durch mehrere Stöße mit Satttdampf von $p_e^{^1}$ bar mit jeweils anschließender Druckentlastung aus dem Sterilisations-Behälter verdrängt.

Fraktioniertes Vakuumverfahren

Bei diesem Verfahren erfolgt die Sterilisation durch:

1. mehrfaches Evakuieren bis zu einem Druck $p_{abs} < 130$ mbar im Wechsel mit Dampfeinströmung auf einen Druck, der unter oder über dem Atmosphärendruck liegt.
2. Dampfeinlassen bis zum Erreichen des Arbeitsdrucks.

Dampfinjektionsverfahren

Bei diesem Verfahren erfolgt die Sterilisation durch:

1. einmaliges Evakuieren bis zu einen Druck $p_{abs} < 70$ mbar bei gleichzeitigem Einströmen geringer Dampfmengen.
2. Dampfeinlassen bis zum Erreichen des Betriebsüberdrucks.

We recommend following steam sterilization procedures for our containers with perforated lids and **non**-perforated bottoms, as specified in DIN 58946/6 standard:

Fractional flow procedure

A few jets of saturated steam of $p_e^{^1}$ bar is generally sufficient to remove the air out of sterilizing chamber.

Fractional vacuum procedure

1. Repeated evacuation up to a pressure of $p_{abs} < 130$ mbar in exchange with steam inflow up to a pressure above or below an atmospheric pressure.
2. Maintaining of steam inflow until the working overpressure is reached.

Steam injection procedure (Vacuum procedure)

1. Single evacuation up to a pressure of $p_{abs} < 70$ mbar with simultaneous low steam inflow.
2. Maintaining of steam inflow until the working overpressure is reached.















Container mit Deckel-Perforation **und** perforiertem Boden sind nach DIN 58946 Teil 1 'Betrieb von Groß-Sterilisatoren' für Graviationsverfahren und Vorvakuumverfahren (siehe Tabelle Seite VI) geeignet.

Containers with perforated lid **and** bottom are suitable for all other gravitation and prevacuum procedures as specified in DIN 58946 Teil 1 standard, please refer to the table on page VI.

Eignung der Sterilisierbehälter für verschiedene Dampfsterilisationsverfahren ¹⁾
 gemäß DIN 58953 Teil 9 (Stand 05.1987)

Suitability of our containers for steam sterilization procedures ¹⁾
 as per DIN 58953 part 9 (issue 05.1987)

Sterilisierbehälter Sterilization container	Art der Verpackung Packing		Dampfsterilisationsverfahren nach DIN 58946 Teil 1 Steam sterilization procedure acc. to DIN 58946 part 1				
	Beschreibung Description	Symbolische Darstellung und Packlage Symbolic representation and packing system	Gravitations- verfahren Gravitation procedure	Vorvakuum- verfahren Pre-vacuum procedure	Fraktioniertes Vakuumverfahren Fractional vacuum procedure	Fraktioniertes Strömungsverfahren Fractional flow procedure	Dampfinjektions- verfahren Steam injection procedure
mit Filter (StB-F) with Filter (StB-F)	Textilien in Sterilisationsbehälter mit Filter in Deckel und Boden nach DIN 58952 Teil 1 Textiles in sterilization container with filter in lid and bottom acc. to DIN 58952 part 1		+	+	+	+	+
	Textilien in Sterilisationsbehälter mit Filter im Deckel, Boden nicht perforiert, nach DIN 58952 Teil 1 Textiles in sterilization container with filter in lid, bottom not perforated, acc. to DIN 58952 part 1		○	○	+	+	+
	Textilien in Sterilisationsbehälter mit Filter im Boden, Deckel nicht perforiert, nach DIN 58952 Teil 1 Textiles in sterilization container with filter in bottom, lid not perforated, acc. to DIN 58952 part 1		○	+	+	+	+
	Textilien in Sterilisationsbehälter mit Filter im Boden, Deckel nicht perforiert, nach DIN 58952 Teil 1 Textiles in sterilization container with filter in bottom, lid not perforated, acc. to DIN 58952 part 1		○	+	+	+	+
	Instrumente auf Sterilisiersiebschale nach DIN 58952 Teil 3 in StB mit Filter in Deckel und Boden nach DIN 58952 Teil 1 Instruments in wire basket acc. to DIN 58952 part 3 in StB with filter in lid and bottom acc. to DIN 58952 part 1		+ ³⁾	+	+	+	+
	Instrumente auf Sterilisiersiebschale nach DIN 58952 Teil 3 in StB mit Filter im Deckel, Boden nicht perforiert, nach DIN 58952 Teil 1 Instruments in wire basket acc. to DIN 58952 part 3, in StB with filter in lid, bottom not perforated, acc. to DIN 58952 part 1		-	+ ²⁾	+ ²⁾	+ ²⁾	+ ²⁾
	Instrumente auf Sterilisiersiebschale nach DIN 58952 Teil 3 in StB mit Filter im Boden, Deckel nicht perforiert, nach DIN 58952 Teil 1 Instruments in wire basket acc. to DIN 58952 part 3, in StB with filter in bottom, lid not perforated, acc. to DIN 58952 part 1		○	+	+	+	+
mit Ventilen (StB-V) with Valves (StB-V)	Textilien in Sterilisationsbehälter mit Ventilen in Deckel und Boden nach DIN 58952 Teil 1 Textiles in sterilization container with valves in lid and bottom acc. to DIN 58952 part 1		-	○	+	+	○
	Textilien in Sterilisationsbehälter mit Ventil im Deckel, kein Ventil am Boden Textiles in sterilization container with valve in lid, no valve on the bottom		-	-	+	+	○
	Textilien in Sterilisationsbehälter mit Ventil im Deckel, kein Ventil am Boden Textiles in sterilization container with valve in lid, no valve on the bottom		-	-	+	+	-
	Instrumente auf Sterilisiersiebschale in StB mit Ventilen in Deckel und Boden Instruments in wire basket in StB with valves in lid and bottom		-	+ ²⁾	+ ²⁾	+ ²⁾	+ ²⁾
	Instrumente auf Sterilisiersiebschale in StB mit Ventil im Deckel, Boden nicht perforiert Instruments in wire basket in StB with valve in lid, bottom not perforated		-	+ ²⁾	+ ²⁾	+ ²⁾	+ ²⁾

Zeichenerklärung/Explanation of symbols: + anwendbar/applicable - nicht anwendbar/not applicable ○ bedingt anwendbar/limited application

- Um Behandlungs- und/oder Anwendungsfehler zu vermeiden, werden in der Tabelle Hinweise für die richtige oder falsche Kombination von Sterilisierbehältern mit genormten Dampfsterilisationsverfahren gegeben.
In order to avoid mistakes with regards to service, operation and/or when loading the sterilizer, please refer to table for correct or wrong combination of sterilization containers for standardized steam sterilization procedures.
- Geeignet sind nur solche Sterilisationsbehälter, bei denen die Verdampfung oder Ableitung des Kondensats sichergestellt ist.
Suitable are only sterilizations containers guaranteeing evaporation or discharge of condensate.
- Beim Gravitationsverfahren ohne Trocknungseinrichtung ist eine ausreichende Nachtrocknung nicht gegeben.
Gravitation procedures having no drying device do not guarantee a sufficient after-drying effect.

Standard-Container Standard-Containers



Die Standard-Container sind mit und ohne perforiertem Boden erhältlich. Die Filter sind nicht gegen Verschmutzung durch Flüssigkeiten, Staub oder mechanische Einwirkung geschützt.

The Standard-Containers are available with perforated or with non-perforated bottoms. Filters are not protected against contamination from liquids, dust and mechanical effects.



Die Deckel sind in 6 verschiedenen Farben erhältlich.
The lids are available in 6 different colours.

Sicherheits-Container
Safety Containers

Bei den Sicherheits-Containern sind die Deckel-Filter durch einen Überdeckel geschützt.

Safety Containers are fitted with a safety lid protecting filters.



Die Überdeckel sind in 6 Farben lieferbar.
Safety lids are available in 6 different colours.



Vorderansicht General front view

Jeder Container kann mit zwei Kennzeichnungsschildern versehen werden: Eines für die jeweilige medizinische Abteilung, eines für die betreffende Operation. Die Schilder lassen sich leicht in die dafür vorgesehenen Schlitze einschieben und sind mit Federdruck gesichert.

Each container can be equipped with two identification labels: One for the surgical department which the container belongs to, one for the name of the operation. They are easily slid into their built-in slots and firmly secured by a spring enforcement.

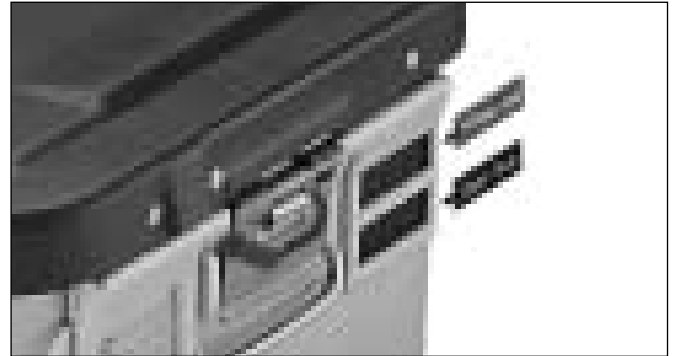

Die Angaben auf dem Indikator-Schild werden vor dem Sterilisationsvorgang eingetragen. Die Schilder werden dann in ihre federdruckgesicherten Schlitze eingeschoben.

Information on indicator label are filled in before sterilization process and inserted into their spring-enforced slots.

Ein Sicherheitssiegel schützt den Container vor unbefugtem Öffnen. Das Siegel bricht automatisch auf, sobald die Verschlusskappe hochgehoben wird.

A security seal is used to keep the container lock safe from unauthorized opening, and breaks automatically only when the locking flap is lifted.



Die Verschlussklappen (1) sind bis zu einem Öffnungswinkel von 180° schwenkbar. Sie können in jeder Position festgestellt werden.

Die Deckel sind rundum, in der Mitte und am Außenrand der Filterhalterung mit vollständig eingelassenen Silikondichtungen (2) versehen.

Locking flaps (1) are movable 180° and can be secured in any position.

Silicon sealing (2) is provided around the lid, the centre and outside of the filter retainer, completely recessed.



Die Filterhalterung wird auf Daumendruck verriegelt. Sie entriegelt sich beim Hochziehen. Dadurch kann der Filter leicht und rasch ausgetauscht werden. Bei der Herstellung des Verschlusssystems wird kein Kunststoff verwendet.

Filter retainer is locked up when pressed down with thumb force and opens when you pull it up. This ensures a practical and quick filter change. No plastic based material is used in the production of the locking system.

Sicherheitsdeckel

Safety Lid

Hochheben des Containerdeckels: Schieben Sie das Schloß in Pfeilrichtung "1" und halten Sie den Riegel fest und ziehen Sie in Pfeilrichtung "2".

Befestigen des Sicherheitsdeckels: Setzen sie ihn einfach auf den Containerdeckel auf und drücken Sie ihn hinunter.

To lift off container lid: Push lock in the direction of arrow "1", hold lid latch, pull in the direction of arrow "2".

For mounting safety lid, simply place it on container lid and press down.

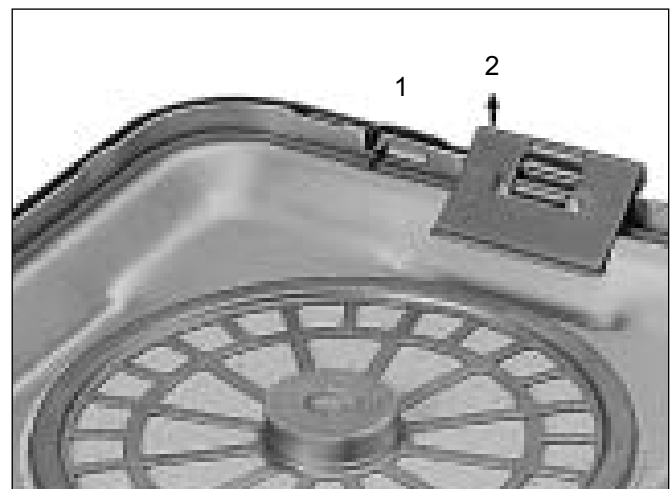



Standard-Container
Standard-Containers



Sicherheits-Container
Safety-Containers

Standard-Container komplett
 Standard Containers complete

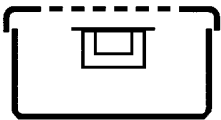
 Wanne nicht perforiert
 Bottom non perforated

Abmessungen Measurements	Silber Silver	Gold Gold	Rot Red	Blau Blue	Grün Green	Anthrazit Dark Grey
580 x 280 x 100 mm	19E-100.01	19E-100.02	19E-100.03	19E-100.04	19E-100.05	19E-100.06
580 x 280 x 135 mm	19E-101.01	19E-101.02	19E-101.03	19E-101.04	19E-101.05	19E-101.06
580 x 280 x 150 mm	19E-102.01	19E-102.02	19E-102.03	19E-102.04	19E-102.05	19E-102.06
580 x 280 x 200 mm	19E-103.01	19E-103.02	19E-103.03	19E-103.04	19E-103.05	19E-103.06
580 x 280 x 260 mm	19E-104.01	19E-104.02	19E-104.03	19E-104.04	19E-104.05	19E-104.06

 Wanne perforiert
 Bottom perforated

Abmessungen Measurements	Silber Silver	Gold Gold	Rot Red	Blau Blue	Grün Green	Anthrazit Dark Grey
580 x 280 x 100 mm	19E-105.01	19E-105.02	19E-105.03	19E-105.04	19E-105.05	19E-105.06
580 x 280 x 135 mm	19E-106.01	19E-106.02	19E-106.03	19E-106.04	19E-106.05	19E-106.06
580 x 280 x 150 mm	19E-107.01	19E-107.02	19E-107.03	19E-107.04	19E-107.05	19E-107.06
580 x 280 x 200 mm	19E-108.01	19E-108.02	19E-108.03	19E-108.04	19E-108.05	19E-108.06
580 x 280 x 260 mm	19E-109.01	19E-109.02	19E-109.03	19E-109.04	19E-109.05	19E-109.06

 Sicherheits-Container komplett
 Safety Containers complete

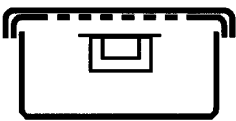
 Wanne nicht perforiert
 Bottom non perforated

Abmessungen Measurements	Silber Silver	Gold Gold	Rot Red	Blau Blue	Grün Green	Anthrazit Dark Grey
580 x 280 x 100 mm	19E-110.01	19E-110.02	19E-110.03	19E-110.04	19E-110.05	19E-110.06
580 x 280 x 135 mm	19E-111.01	19E-111.02	19E-111.03	19E-111.04	19E-111.05	19E-111.06
580 x 280 x 150 mm	19E-112.01	19E-112.02	19E-112.03	19E-112.04	19E-112.05	19E-112.06
580 x 280 x 200 mm	19E-113.01	19E-113.02	19E-113.03	19E-113.04	19E-113.05	19E-113.06
580 x 280 x 260 mm	19E-114.01	19E-114.02	19E-114.03	19E-114.04	19E-114.05	19E-114.06

 Wanne perforiert
 Bottom perforated

Abmessungen Measurements	Silber Silver	Gold Gold	Rot Red	Blau Blue	Grün Green	Anthrazit Dark Grey
580 x 280 x 100 mm	19E-115.01	19E-115.02	19E-115.03	19E-115.04	19E-115.05	19E-115.06
580 x 280 x 135 mm	19E-116.01	19E-116.02	19E-116.03	19E-116.04	19E-116.05	19E-116.06
580 x 280 x 150 mm	19E-117.01	19E-117.02	19E-117.03	19E-117.04	19E-117.05	19E-117.06
580 x 280 x 200 mm	19E-118.01	19E-118.02	19E-118.03	19E-118.04	19E-118.05	19E-118.06
580 x 280 x 260 mm	19E-119.01	19E-119.02	19E-119.03	19E-119.04	19E-119.05	19E-119.06

Boden
Bottoms



Abmessungen Measurements	Wanne nicht perforiert Bottom non perforated	Wanne perforiert Bottom perforated
580 x 280 x 100 mm	19E-120.01	19E-121.01
580 x 280 x 135 mm	19E-120.02	19E-121.02
580 x 280 x 150 mm	19E-120.03	19E-121.03
580 x 280 x 200 mm	19E-120.04	19E-121.04
580 x 280 x 260 mm	19E-120.05	19E-121.05

Deckel
Lids



580 x 280 mm	Deckel perforiert Lid perforated	Sicherheits-Deckel Safety Lid
Silber / Silver	19E-122.01	19E-123.01
Gold / Gold	19E-122.02	19E-123.02
Rot / Red	19E-122.03	19E-123.03
Blau / Blue	19E-122.04	19E-123.04
Grün / Green	19E-122.05	19E-123.05
Anthrazit / Dark Grey	19E-122.06	19E-123.06

Sieb Körbe
Wire Baskets



Abmessungen Measurements	Katalog Nummer Catalog Nunmer
485 x 255 x 30 mm	19E-128.01
485 x 255 x 50 mm	19E-128.02
485 x 255 x 70 mm	19E-128.03
485 x 255 x 100 mm	19E-128.04



Abmessungen Measurements	Katalog Nummer Catalog Nunmer
540 x 255 x 30 mm	19E-129.01
540 x 255 x 50 mm	19E-129.02
540 x 255 x 70 mm	19E-129.03
540 x 255 x 100 mm	19E-129.04

 Siebboden
Wire Base

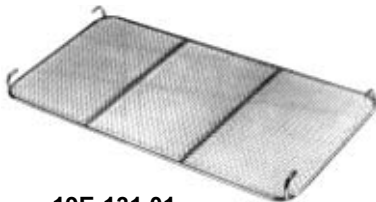
545 x 255 x 30 mm

**19E-131.01**
 Spannrahmen
Drape Retainer

545 x 255 mm

**19E-133.01**
 Tücher
Drape

Abmessungen Measurements	Katalog Nummer Catalog Nunmer
130 x 60 cm	19E-137.07
140 x 100 cm	19E-137.08
185 x 45 cm	19E-137.09
185 x 60 cm	19E-137.10



Standard-Container
Standard-Containers



Sicherheits-Container
Safety-Containers

Standard-Container komplett
 Standard Containers complete

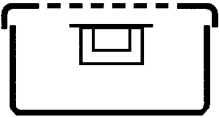
 Wanne nicht perforiert
 Bottom non perforated

Abmessungen Measurements	Silber Silver	Gold Gold	Rot Red	Blau Blue	Grün Green	Anthrazit Dark Grey
465 x 280 x 100 mm	19E-147.01	19E-147.02	19E-147.03	19E-147.04	19E-147.05	19E-147.06
465 x 280 x 135 mm	19E-148.01	19E-148.02	19E-148.03	19E-148.04	19E-148.05	19E-148.06
465 x 280 x 150 mm	19E-149.01	19E-149.02	19E-149.03	19E-149.04	19E-149.05	19E-149.06

 Wanne perforiert
 Bottom perforated

Abmessungen Measurements	Silber Silver	Gold Gold	Rot Red	Blau Blue	Grün Green	Anthrazit Dark Grey
465 x 280 x 100 mm	19E-155.01	19E-155.02	19E-155.03	19E-155.04	19E-155.05	19E-155.06
465 x 280 x 135 mm	19E-156.01	19E-156.02	19E-156.03	19E-156.04	19E-156.05	19E-156.06
465 x 280 x 150 mm	19E-157.01	19E-157.02	19E-157.03	19E-157.04	19E-157.05	19E-157.06

 Sicherheits-Container komplett
 Safety Containers complete

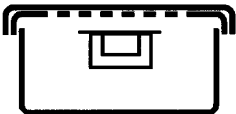
 Wanne nicht perforiert
 Bottom non perforated

Abmessungen Measurements	Silber Silver	Gold Gold	Rot Red	Blau Blue	Grün Green	Anthrazit Dark Grey
465 x 280 x 100 mm	19E-160.01	19E-160.02	19E-160.03	19E-160.04	19E-160.05	19E-160.06
465 x 280 x 135 mm	19E-161.01	19E-161.02	19E-161.03	19E-161.04	19E-161.05	19E-161.06
465 x 280 x 150 mm	19E-162.01	19E-162.02	19E-162.03	19E-162.04	19E-162.05	19E-162.06

 Wanne perforiert
 Bottom perforated

Abmessungen Measurements	Silber Silver	Gold Gold	Rot Red	Blau Blue	Grün Green	Anthrazit Dark Grey
465 x 280 x 100 mm	19E-165.01	19E-165.02	19E-165.03	19E-165.04	19E-165.05	19E-165.06
465 x 280 x 135 mm	19E-166.01	19E-166.02	19E-166.03	19E-166.04	19E-166.05	19E-166.06
465 x 280 x 150 mm	19E-167.01	19E-167.02	19E-167.03	19E-167.04	19E-167.05	19E-167.06

Boden Bottoms



Abmessungen Measurements	Wanne nicht perforiert Bottom non perforated	Wanne perforiert Bottom perforated
465 x 280 x 100 mm	19E-170.01	19E-171.01
465 x 280 x 135 mm	19E-170.02	19E-171.02
465 x 280 x 150 mm	19E-170.03	19E-171.03

Deckel Lids



465 x 280 mm	Deckel perforiert Lid perforated	Sicherheits-Deckel Safety Lid
Silber / Silver	19E-172.01	19E-173.01
Gold / Gold	19E-172.02	19E-173.02
Rot / Red	19E-172.03	19E-173.03
Blau / Blue	19E-172.04	19E-173.04
Grün / Green	19E-172.05	19E-173.05
Anthrazit / Dark Grey	19E-172.06	19E-173.06

Sieb Körbe
Wire Baskets

Abmessungen Measurements	Katalog Nummer Catalog Nummer
405 x 255 x 30 mm	19E-178.01
405 x 255 x 50 mm	19E-178.02
405 x 255 x 70 mm	19E-178.03
405 x 255 x 100 mm	19E-178.04

 Siebboden
Wire Base

405 x 255 x 30 mm

**19E-180.01**
 Spannrahmen
Drape Retainer

405 x 255 mm

**19E-182.01**
 Tücher
Drape

140 x 100 cm

**19E-137.08**



Standard-Container
Standard-Containers



Sicherheits-Container
Safety-Containers

Standard-Container komplett
 Standard Containers complete

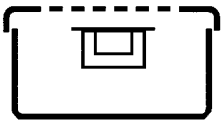
 Wanne nicht perforiert
 Bottom non perforated

Abmessungen Measurements	Silber Silver	Gold Gold	Rot Red	Blau Blue	Grün Green	Anthrazit Dark Grey
285 x 280 x 100 mm	19E-190.01	19E-190.02	19E-190.03	19E-190.04	19E-190.05	19E-190.06
285 x 280 x 135 mm	19E-191.01	19E-191.02	19E-191.03	19E-191.04	19E-191.05	19E-191.06
285 x 280 x 150 mm	19E-192.01	19E-192.02	19E-192.03	19E-192.04	19E-192.05	19E-192.06
285 x 280 x 200 mm	19E-193.01	19E-193.02	19E-193.03	19E-193.04	19E-193.05	19E-193.06
285 x 280 x 260 mm	19E-194.01	19E-194.02	19E-194.03	19E-194.04	19E-194.05	19E-194.06

 Wanne perforiert
 Bottom perforated

Abmessungen Measurements	Silber Silver	Gold Gold	Rot Red	Blau Blue	Grün Green	Anthrazit Dark Grey
285 x 280 x 100 mm	19E-195.01	19E-195.02	19E-195.03	19E-195.04	19E-195.05	19E-195.06
285 x 280 x 135 mm	19E-196.01	19E-196.02	19E-196.03	19E-196.04	19E-196.05	19E-196.06
285 x 280 x 150 mm	19E-197.01	19E-197.02	19E-197.03	19E-197.04	19E-197.05	19E-197.06
285 x 280 x 200 mm	19E-198.01	19E-198.02	19E-198.03	19E-198.04	19E-198.05	19E-198.06
285 x 280 x 260 mm	19E-199.01	19E-199.02	19E-199.03	19E-199.04	19E-199.05	19E-199.06

 Sicherheits-Container komplett
 Safety Containers complete

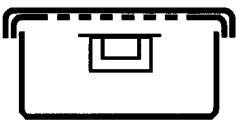
 Wanne nicht perforiert
 Bottom non perforated

Abmessungen Measurements	Silber Silver	Gold Gold	Rot Red	Blau Blue	Grün Green	Anthrazit Dark Grey
285 x 280 x 100 mm	19E-200.01	19E-200.02	19E-200.03	19E-200.04	19E-200.05	19E-200.06
285 x 280 x 135 mm	19E-201.01	19E-201.02	19E-201.03	19E-201.04	19E-201.05	19E-201.06
285 x 280 x 150 mm	19E-202.01	19E-202.02	19E-202.03	19E-202.04	19E-202.05	19E-202.06
285 x 280 x 200 mm	19E-203.01	19E-203.02	19E-203.03	19E-203.04	19E-203.05	19E-203.06
285 x 280 x 260 mm	19E-204.01	19E-204.02	19E-204.03	19E-204.04	19E-204.05	19E-204.06

 Wanne perforiert
 Bottom perforated

Abmessungen Measurements	Silber Silver	Gold Gold	Rot Red	Blau Blue	Grün Green	Anthrazit Dark Grey
285 x 280 x 100 mm	19E-205.01	19E-205.02	19E-205.03	19E-205.04	19E-205.05	19E-205.06
285 x 280 x 135 mm	19E-206.01	19E-206.02	19E-206.03	19E-206.04	19E-206.05	19E-206.06
285 x 280 x 150 mm	19E-207.01	19E-207.02	19E-207.03	19E-207.04	19E-207.05	19E-207.06
285 x 280 x 200 mm	19E-208.01	19E-208.02	19E-208.03	19E-208.04	19E-208.05	19E-208.06
285 x 280 x 260 mm	19E-209.01	19E-209.02	19E-209.03	19E-209.04	19E-209.05	19E-209.06

Boden Bottoms

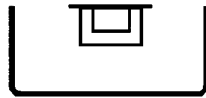

Abmessungen Measurements	Wanne nicht perforiert Bottom non perforated	Wanne perforiert Bottom perforated
285 x 280 x 100 mm	19E-210.01	19E-211.01
285 x 280 x 135 mm	19E-210.02	19E-211.02
285 x 280 x 150 mm	19E-210.03	19E-211.03
285 x 280 x 200 mm	19E-210.04	19E-211.04
285 x 280 x 260 mm	19E-210.05	19E-211.05

Deckel Lids



285 x 280 mm	Deckel perforiert Lid perforated	Sicherheits-Deckel Safety Lid
Silber / Silver	19E-212.01	19E-213.01
Gold / Gold	19E-212.02	19E-213.02
Rot / Red	19E-212.03	19E-213.03
Blau / Blue	19E-212.04	19E-213.04
Grün / Green	19E-212.05	19E-213.05
Anthrazit / Dark Grey	19E-212.06	19E-213.06

Sieb Körbe
Wire Baskets

Abmessungen Measurements	Katalog Nummer Catalog Nunmer
255 x 245 x 30 mm	19E-218.01
255 x 245 x 50 mm	19E-218.02
255 x 245 x 70 mm	19E-218.03
255 x 245 x 100 mm	19E-218.04

 Siebboden
Wire Base

255 x 258 x 30 mm

**19E-220.01**
 Spannrahmen
Drape Retainer

255 x 255 mm

**19E-221.01**
 Tücher
Drape



Abmessungen Measurements	Katalog Nummer Catalog Nunmer
90 x 60 cm	19E-137.04
90 x 80 cm	19E-137.05
130 x 45 cm	19E-137.06
130 x 60 cm	19E-137.07



Entsorgungs-Container komplett
Removal Containers complete

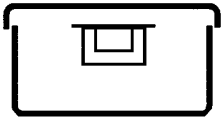

Deckel und Wanne
nicht perforiert
Lid and Bottom
non perforated



Abmessungen Measurements	Silber Silver	Gold Gold	Rot Red	Blau Blue	Grün Green	Anthrazit Dark Grey
285 x 280 x 100 mm	19E-230.01	19E-230.02	19E-230.03	19E-230.04	19E-230.05	19E-230.06
285 x 280 x 150 mm	19E-232.01	19E-232.02	19E-232.03	19E-232.04	19E-232.05	19E-232.06
580 x 280 x 150 mm	19E-235.01	19E-235.02	19E-235.03	19E-235.04	19E-235.05	19E-235.06

Boden
Bottoms



Wanne nicht perforiert
Bottom non perforated



Abmessungen Measurements	Wanne nicht perforiert Bottom non perforated
285 x 280 x 100 mm	19E-210.01
285 x 280 x 150 mm	19E-210.03
580 x 280 x 150 mm	19E-120.03

Deckel
Lids

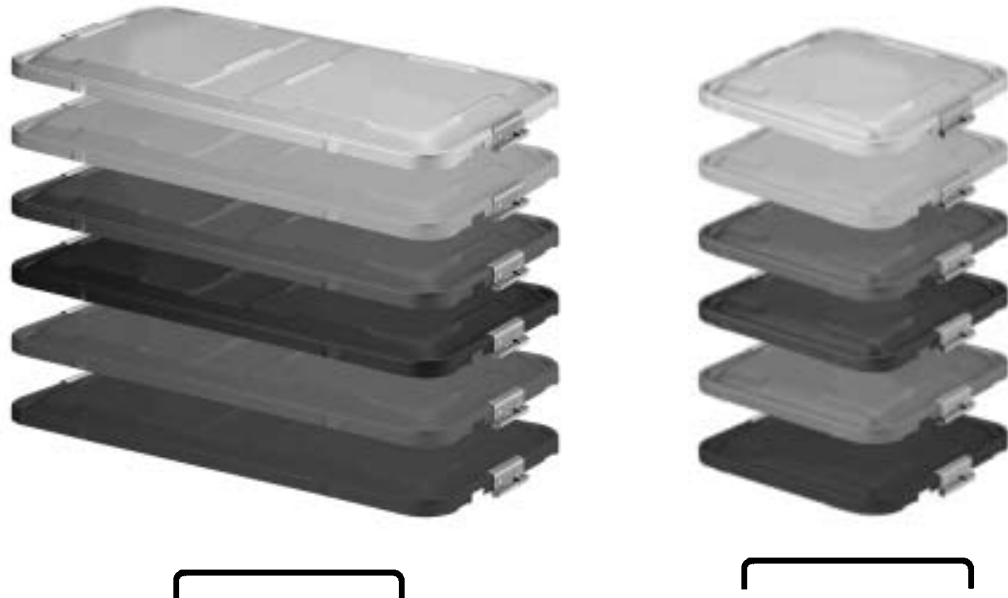

Deckel nicht perforiert Lid non perforated	580 x 280 mm	285 x 280 mm
Silber / Silver	19E-239.01	19E-240.01
Gold / Gold	19E-239.02	19E-240.02
Rot / Red	19E-239.03	19E-240.03
Blau / Blue	19E-239.04	19E-240.04
Grün / Green	19E-239.05	19E-240.05
Anthrazit / Dark Grey	19E-239.06	19E-240.06

Flach-Container komplett
Flat Containers complete



Wanne nicht perforiert
Bottom non perforated



Abmessungen Measurements	Silber Silver	Gold Gold	Rot Red	Blau Blue	Grün Green
285 x 280 x 55 mm	19E-250.01	19E-250.02	19E-250.03	19E-250.04	19E-250.05
285 x 280 x 85 mm	19E-251.01	19E-251.02	19E-251.03	19E-251.04	19E-251.05

Wanne perforiert
Bottom perforated



Abmessungen Measurements	Silber Silver	Gold Gold	Rot Red	Blau Blue	Grün Green
285 x 280 x 85 mm	19E-253.01	19E-253.02	19E-253.03	19E-253.04	19E-253.05

Boden
Bottoms



Abmessungen Measurements	Wanne nicht perforiert Bottom non perforated	Wanne perforiert Bottom perforated
285 x 280 x 55 mm	19E-254.01	-
285 x 280 x 85 mm	19E-254.02	19E-255.02

Deckel Lids



Deckel perforiert Lid perforated	285 x 280 mm
Silber / Silver	19E-256.01
Gold / Gold	19E-256.02
Rot / Red	19E-256.03
Blau / Blue	19E-256.04
Grün / Green	19E-256.05

Sieb Körbe Wire Baskets



Abmessungen Measurements	Katalog Nummer Catalog Nummer
255 x 245 x 30 mm	19E-218.01
255 x 245 x 50 mm	19E-218.02

Tücher Drape



Abmessungen Measurements	Katalog Nummer Catalog Nummer
90 x 60 cm	19E-137.04
90 x 80 cm	19E-137.05

Siebboden Wire Base

255 x 258 x 30 mm



19E-220.01

Silikon Matte Silicon Mat

245 x 245 mm



19E-257.01

Spannrahmen Drape Retainer

255 x 255 mm

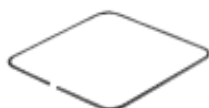

19E-221.01

Mini-Container komplett
Mini Containers complete



Wanne nicht perforiert
Bottom non perforated



Abmessungen Measurements	Silber Silver	Gold Gold	Rot Red	Blau Blue	Grün Green
300 x 140 x 40 mm	19E-260.01	19E-260.02	19E-260.03	19E-260.04	19E-260.05
300 x 140 x 70 mm	19E-261.01	19E-261.02	19E-261.03	19E-261.04	19E-261.05
300 x 140 x 100 mm	19E-262.01	19E-262.02	19E-262.03	19E-262.04	19E-262.05

Wanne perforiert
Bottom perforated



Abmessungen Measurements	Silber Silver	Gold Gold	Rot Red	Blau Blue	Grün Green
300 x 140 x 40 mm	19E-265.01	19E-265.02	19E-265.03	19E-265.04	19E-265.05
300 x 140 x 70 mm	19E-266.01	19E-266.02	19E-266.03	19E-266.04	19E-266.05
300 x 140 x 100 mm	19E-267.01	19E-267.02	19E-267.03	19E-267.04	19E-267.05

Boden
Bottoms

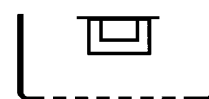

Abmessungen Measurements	Wanne nicht perforiert Bottom non perforated	Wanne perforiert Bottom perforated
300 x 140 x 40 mm	19E-268.01	19E-269.01
300 x 140 x 70 mm	19E-268.02	19E-269.02
300 x 140 x 100 mm	19E-268.03	19E-269.02

Deckel
Lids

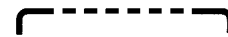

Deckel perforiert Lid perforated	300 x 140 mm
Silber / Silver	19E-270.01
Gold / Gold	19E-270.02
Rot / Red	19E-270.03
Blau / Blue	19E-270.04
Grün / Green	19E-270.05

Tücher
Drape

60 x 40 cm



19E-137.01

Silikon Matte
Silicon Mat

270 x 125 mm



19E-257.02

Spannrahmen
Drape Retainer

280 x 125 mm



19E-271.01

Dental Container
Dental Containers



Abmessungen Measurements	Deckel und Wanne perforiert Lid and Bottom perforated	Wanne perforiert Bottom perforated
310 x 190 x 40 mm	19E-275.01	19E-279.01
310 x 190 x 65 mm	19E-276.01	19E-279.02
310 x 190 x 130 mm	19E-277.01	19E-279.03

Deckel
Lid

310 x 190 mm



19E-280.01

Spannrahmen
Drape Retainer

310 x 190 mm



19E-281.01

Tücher
Drape



Abmessungen Measurements	Katalog Nummer Catalog Nummer
60 x 40 cm	19E-137.01
65 x 65 cm	19E-137.02
85 x 85 cm	19E-137.03

Implantat Container Implant Containers

Deckel und Wanne perforiert
Lid and Bottom perforated



	300 x 138 x 65 mm	500 x 155 x 75 mm
Silber / Silver	19E-285.01	19E-286.01
Gold / Gold	19E-285.02	19E-286.02
Rot / Red	19E-285.03	19E-286.03
Blau / Blue	19E-285.04	19E-286.04
Grün / Green	19E-285.05	19E-286.05

Container für Optiken Telescope Containers

Deckel und Wanne perforiert
Lid and Bottom perforated



	250 x 60 x 50 mm	450 x 70 x 70 mm
Silber / Silver	19E-290.01	19E-291.01

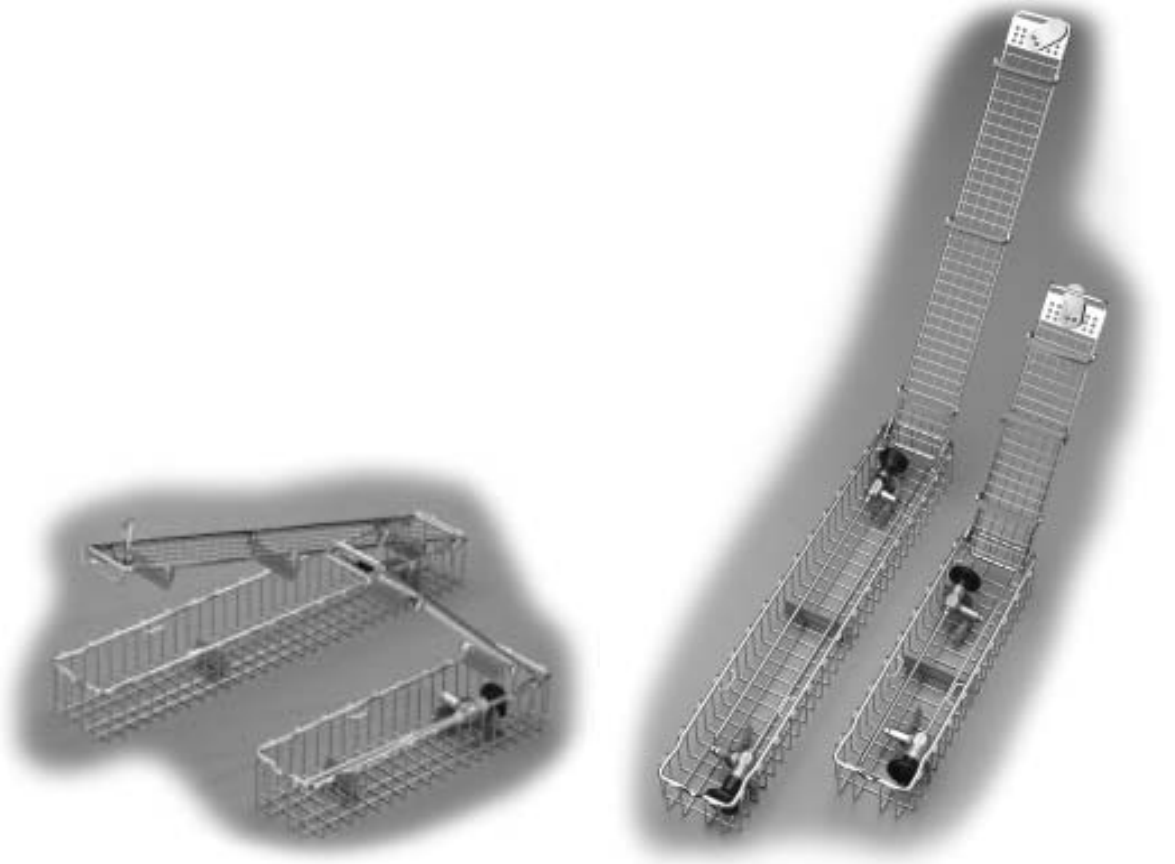

Abmessungen Measurements	für 1 Optik for 1 Telescope	für 2 Optiken for 2 Telescopes
290 x 80 x 52 mm	19E-295.01	19E-296.01
460 x 80 x 52 mm	19E-295.02	19E-296.02
670 x 80 x 52 mm	19E-295.03	–

Filterpapierspender
Filter Dispenser

19E-350.00



Tücher
Drape



Abmessungen Measurements	Katalog Nummer Catalog Nunmer
60 x 40 cm	19E-137.01
65 x 65 cm	19E-137.02
85 x 85 cm	19E-137.03
90 x 60 cm	19E-137.04
90 x 80 cm	19E-137.05
130 x 45 cm	19E-137.06
130 x 60 cm	19E-137.07
140 x 100 cm	19E-137.08
185 x 45 cm	19E-137.09
185 x 60 cm	19E-137.10

Filterhalterung
Filter Holder

19E-351.01
für Papierfilter
for paper filter

19E-351.02
für Textilfilter
for textile filter

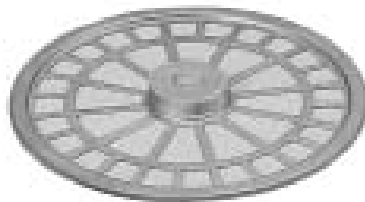

Kennzeichnungsschilder
Identification Lables

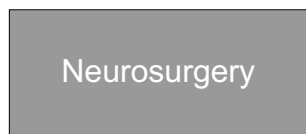

	Kennzeichnungsschilder, Text bis zu 16 Stellen Identification Lables, engraved max. 16 letters	Kennzeichnungsschilder, unbeschriftet Identification Lables, not engraved
Silber / Silver	19E-352.01	19E-353.01
Gold / Gold	19E-352.02	19E-353.02
Rot / Red	19E-352.03	19E-353.03
Blau / Blue	19E-352.04	19E-353.04
Grün / Green	19E-352.05	19E-353.05
Anthrazit / Dark Grey	19E-352.06	19E-353.06

Sortier-Magazin für
Kennzeichnungsschilder

Dispenser for
Identification Lables

19E-354.00



Haltestifte
Holding Pins

19E-355.01
für Drahtkörbe
for wire baskets



19E-355.02
für Trennbleche
for partition sheets

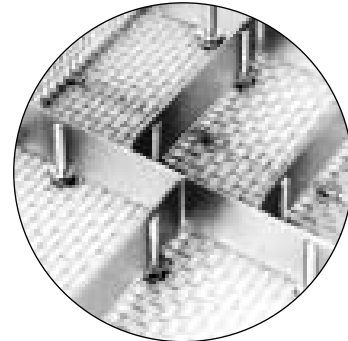

Trennbleche
Partition Sheets

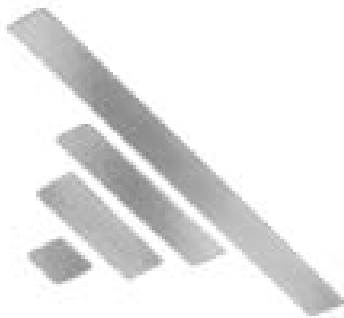

Abmessungen Measurements	Katalog Nummer Catalog Nunner
50 x 20 mm	19E-356.01
130 x 20 mm	19E-356.02
225 x 20 mm	19E-356.03
460 x 20 mm	19E-356.04

Gleitschieber
Divider

19E-357.00

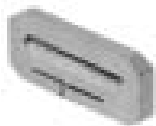

Schienen für Gleitschieber
Sliding Rails for Divider

19E-358.01 232 mm

19E-358.02 471 mm

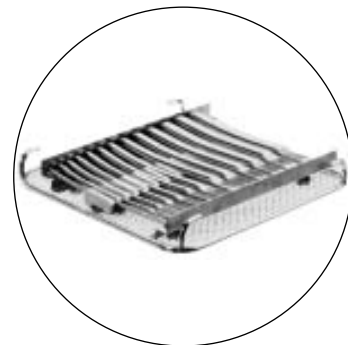

Anschlagrahmen
Limiting Bars

19E-359.01 232 mm

19E-359.02 471 mm



Spiralfeder-Haltevorrichtung
Spiral Holding

19E-360.01 einfach / single

19E-360.02 doppelt / double

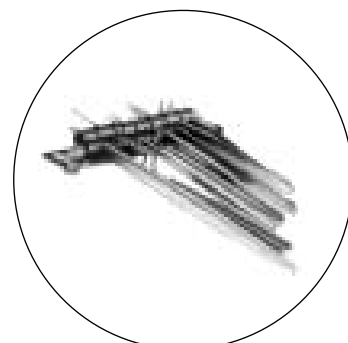

Fixierklammer
Fixation Clamp

19E-361.00

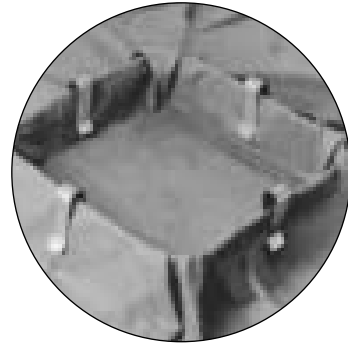

Einmal-Papierfilter
Disposable Paper Filters

Packung 100 Stk.
100 Pcs. / Package

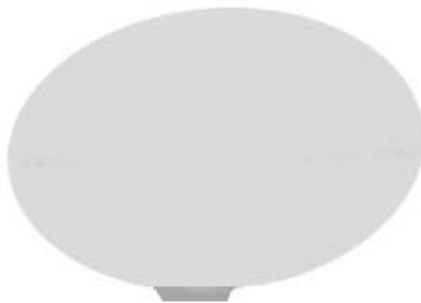

19E-370.01 für 1/1, 3/4 und 1/2 - Container
for 1/1, 3/4 and 1/2 - Containers



19E-370.02 für Mini-Container
for Mini Containers

19E-370.03 für Dental-Container
for Dental Containers

Langzeit Textilfilter
Textile Filters



19E-371.01 für 1/1, 3/4 und 1/2 - Container
for 1/1, 3/4 and 1/2 - Containers



19E-371.02 für Mini-Container
for Mini Containers

19E-371.03 für Dental-Container
for Dental Containers

Indikatorschilder
Paper Label with Indicator

Packung 100 Stk.
100 Pcs. / Package



19E-372.01 für 1/1, 3/4 und 1/2 - Container
for 1/1, 3/4 and 1/2 - Containers



19E-370.02 für Mini und Dental Container
for Mini and Dental Containers

Plombe
Plastic Security Seal

Packung 100 Stk.
100 Pcs. / Package



19E-373.01

Verschußsiegel
Security Seal

Packung 1000 Stk.
100 Pcs. / Package



19E-374.01

Verschußetiketten
Seal Label

Packung 1000 Stk.
100 Pcs. / Package

118 x 39 mm

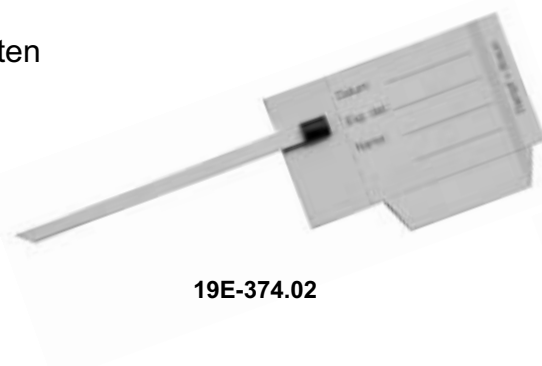

19E-374.02



19E-374.03
selbstklebend
self-adhesive

Instrumentenpflegeöl
Oil for Instrument Care



19E-380.01
400 ml

für chirurgische Instrumente
for surgical instruments



19E-380.02
50 ml

für Druckluftmaschinen und
sterilisierbare Motorsysteme
for air-driven machineries
and sterilizable motor-systems



19E-381.01
1000 ml

für chirurgische Instrumente
for surgical instruments



19E-381.02
400 ml

PE Pumpsprayflasche für 19E-381.01
(ohne Inhalt)
PE Pumpspray-Bottle for 19E-381.01
(unfilled)

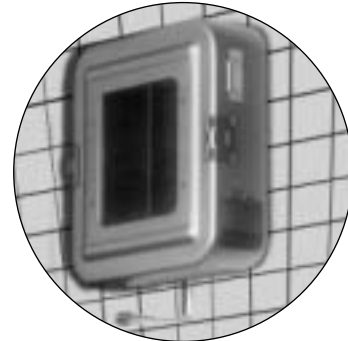
Bürsten Spender
Brush Dispensers

für 20 Bürsten for 20 brushes	285 x 280 x 85 mm
Silber / Silver	19E-400.01
Gold / Gold	19E-400.02
Rot / Red	19E-400.03
Blau / Blue	19E-400.04
Grün / Green	19E-400.05

 Bürsten
Brushes

19E-405.00

Wagen
Trolley



19E-420.00
720 x 620 x 800 mm

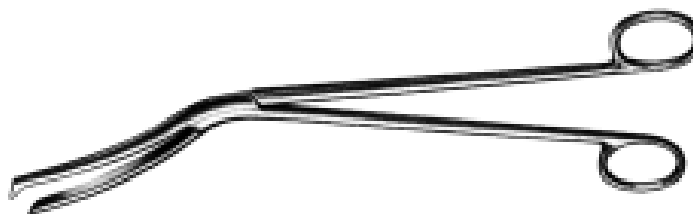

19E-421.00
1030 x 620 x 1170 mm

Sterilisierzangen
Sterilizing Forceps19E-005 Cheattle
27 cm, 10¹/₂"

19E-006 30 cm, 12"

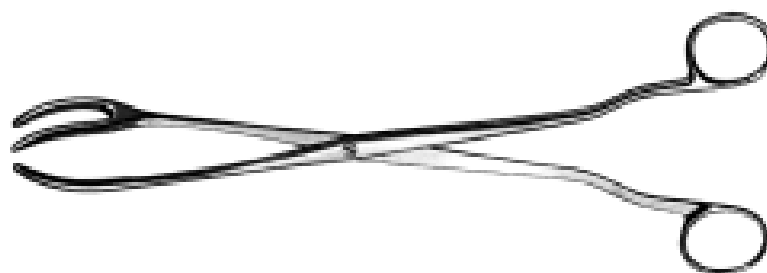
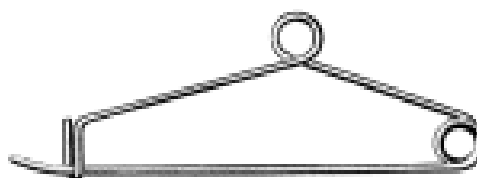
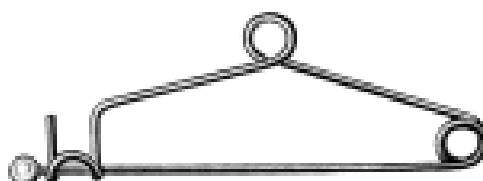
Sterilisierklammeren
Sterilizing Clamps19E-017 Bunt
10,5 cm, 4"19E-018 Mayo
14,5 cm, 5¹/₂"19E-019 Mayo
14,5 cm, 5¹/₂"

Instrumentenkästen Instrument Boxes

Art. Nr. Art. No.	L x B x H l x w x h
19E-021.01	165 x 90 x 35 mm
19E-021.02	200 x 100 x 50 mm
19E-021.03	220 x 150 x 50 mm
19E-021.04	260 x 150 x 50 mm
19E-021.05	305 x 205 x 50 mm



Schalen Trays

Art. Nr. Art. No.	L x B x H l x w x h
19E-022.01	210 x 160 x 10 mm
19E-022.02	240 x 180 x 10 mm
19E-022.03	310 x 150 x 10 mm
19E-022.04	310 x 210 x 10 mm
19E-022.05	350 x 240 x 10 mm
19E-022.06	400 x 270 x 10 mm
19E-022.07	420 x 280 x 10 mm



Art. Nr. Art. No.	L x B x H l x w x h
19E-023.01	230 x 155 x 30 mm
19E-023.02	300 x 175 x 30 mm
19E-023.03	300 x 175 x 40 mm
19E-023.04	350 x 240 x 36 mm
19E-023.05	400 x 300 x 50 mm



Standgefäße
Jars

Art. Nr. Art. No.	Ø x H Ø x h
19E-024.01	30 x 90 mm
19E-024.02	50 x 100 mm
19E-024.03	50 x 130 mm
19E-024.04	50 x 175 mm
19E-024.05	75 x 100 mm
19E-024.06	75 x 130 mm
19E-024.07	75 x 175 mm

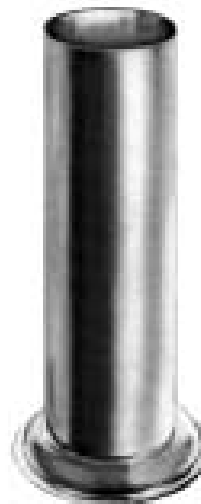
 Spülschalen
Solution Bowls

Art. Nr. Art. No.	Liter litres	Ø x H Ø x h
19E-025.01	0,75	165 x 60 mm
19E-025.02	1,00	175 x 70 mm
19E-025.03	2,00	220 x 80 mm
19E-025.04	2,50	225 x 90 mm
19E-025.05	3,00	240 x 110 mm
19E-025.06	4,50	275 x 115 mm
19E-025.07	6,00	290 x 125 mm
19E-025.08	6,00	310 x 120 mm
19E-025.09	8,50	345 x 125 mm
19E-025.10	11,00	380 x 130 mm



Art. Nr. Art. No.	Liter litres	Ø x H Ø x h
19E-026.01	0,05	40 x 19 mm
19E-026.02	0,07	61 x 30 mm
19E-026.03	0,14	80 x 40 mm
19E-026.04	0,35	116 x 50 mm
19E-026.05	0,45	128 x 55 mm
19E-026.06	0,70	147 x 65 mm



Messbecher
Measures

Art. Nr. Art. No.	Liter litres
19E-027.01	0,25
19E-027.02	0,50
19E-027.03	1,00
19E-027.04	2,00



Nierenschalen
Kidney Bowls

Art. Nr. Art. No.	Länge Length
19E-028.01	170 mm
19E-028.02	250 mm
19E-028.03	275 mm

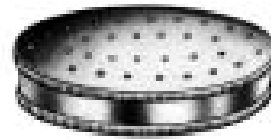

Nadel-Sterilisierdosen
 Needle Sterilizing Boxes

19E-029.00 komplett
complete

19E-029.01 Innendose, allein
Insert, only

19E-030.01 50 x 25 x 4,5 mm

19E-030.02 65 x 42 x 8,0 mm

19E-030.03 75 x 25 x 4,5 mm

19E-031.00 150 x 95 x 13 mm

19E-032.00 Sauerbruch
210 x 125 x 17 mm