

OTOLOGIE
OTOLOGY

Kiefer- und Stirnhöhlen-Spülkanülen
Antrum and Frontal Sinus Wash Cannulas

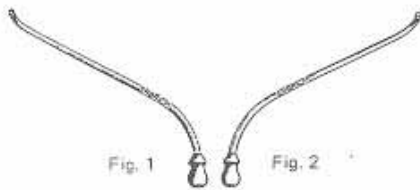

Hartmann		
Fig.1	φ mm	Fig.2
12E-001	2,0	12E-002
12E-003	2,5	12E-004
12E-005	3,0	12E-006



Hartmann	Fig.
12E-007	0
12E-008	1
12E-009	2
12E-010	3
12E-011	4
12E-012	5



φ	Fr.	
	7,5 cm	10,0 cm
3	12E-018	12E-021
5	12E-019	12E-022
7	12E-020	12E-023

Baron

OTOLOGIE
OTOLOGY

Ohrpinzetten
Ear Dressing Forceps

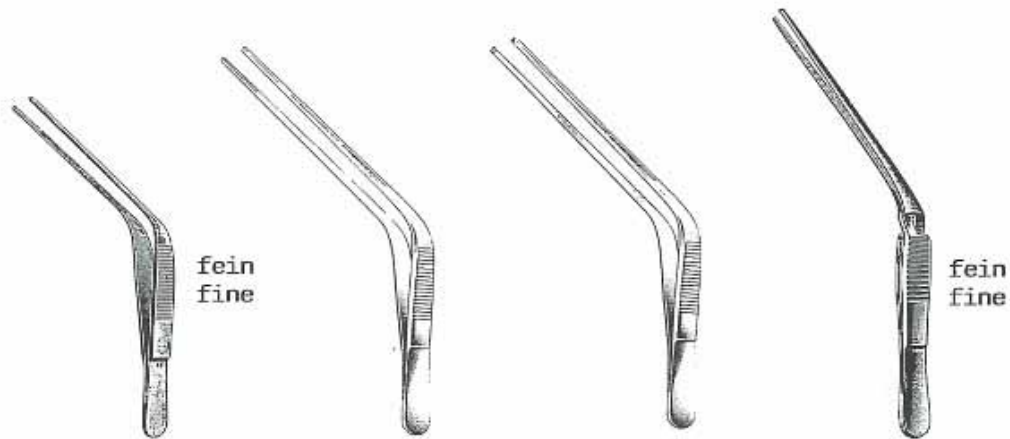

	Troeltsch (Wilde)	Troeltsch (Wilde)	Troeltsch (Wilde) 1:2	Troeltsch (Wilde)
cm	11,0	12,0	12,0	13,0
	12E-048.11	12E-048.00	12E-048.12	12E-055.13

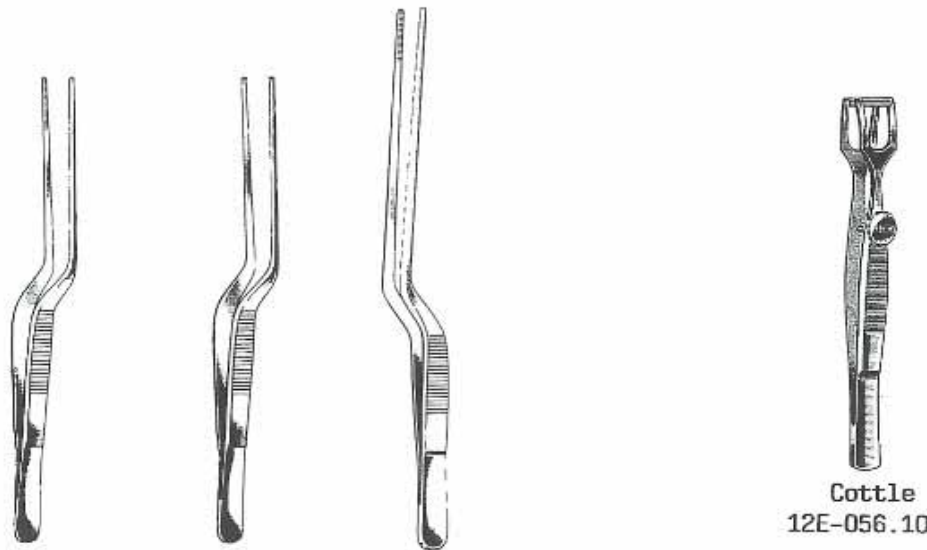

	Lucae	Lucae 1:2	Jansen	Jansen 1:2
cm	14,0	16,0	19,0	21,0
	12E-049.00	12E-049.12	12E-052.00	12E-052.12
			12E-053.00	12E-053.12
			12E-054.00	12E-054.12

Cottle
12E-056.10



12E-040



12E-041



12E-042/043

12E-040 Hartmann Polypenzängchen, fein, 12,0 cm

Hartmann Ear Polypus Forceps, fine pattern, 4³/₄"

12E-041 Hartmann Polypenzängchen, Standard Modell, 14,0 cm

Hartmann Ear Polypus Forceps, Standard Pattern 5¹/₂"

12E-042 Hartmann Ohrpolypenzängchen, gerieftes Alligator- maul, 8,5 cm

Hartmann Ear Polypus Forceps, serrated alligator- jaw, 3¹/₂"

12E-043 Hartmann Ohrpolypenzängchen, gerieftes Alligator- maul, 14,0 cm

Hartmann Ear Polypus Forceps, serrated alligator- jaw, 5¹/₂"

BILLEAU
Ohrschlingen
Ear Loops



16,5 cm



Fig. 1
12E-060.01



Fig. 2
12E-060.02

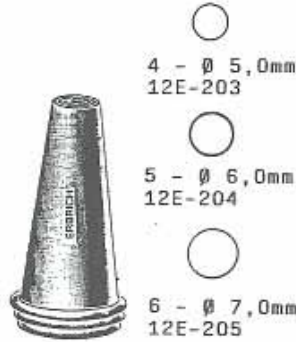

Fig. 3
12E-060.03

OHR SPEKULA
EAR SPECULA
SPECULUMS AURICULAIRES



Troeltsch
12E-208
Fig. 1-3



Troeltsch
12E-209
Fig. 4-6



Gruber
12E-217
Fig. 1-4

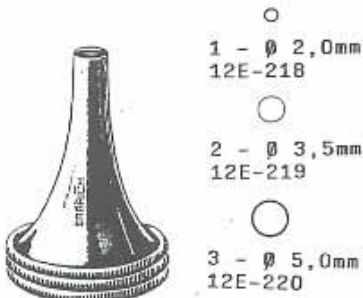

Hartmann
12E-226
Fig. 1-3

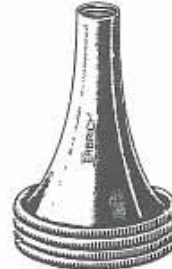

Hartmann
12E-227
Fig. 2-5



Toynbee
12E-236
Fig. 1-4

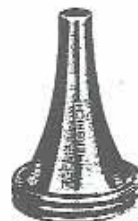

Poltzer
12E-246
Fig. 1-4



Rosen, Luer-Lock
65 mm

0,5 mm	12E-014.05
0,6 mm	12E-014.06
0,7 mm	12E-014.07
0,8 mm	12E-014.08
0,9 mm	12E-014.09
1,0 mm	12E-014.10
1,2 mm	12E-014.12
1,4 mm	12E-014.14
1,5 mm	12E-014.15
1,8 mm	12E-014.18
2,0 mm	12E-014.20
2,1 mm	12E-014.21
2,5 mm	12E-014.25
3,1 mm	12E-014.31



Rosen, Luer-Lock
65 mm

0,5 mm	12E-015.05
0,6 mm	12E-015.06
0,7 mm	12E-015.07
0,8 mm	12E-015.08
0,9 mm	12E-015.09
1,0 mm	12E-015.10
1,2 mm	12E-015.12
1,4 mm	12E-015.14
1,5 mm	12E-015.15
1,8 mm	12E-015.18
2,0 mm	12E-015.20
2,1 mm	12E-015.21
2,5 mm	12E-015.25
3,1 mm	12E-015.31



House, Luer
12E-016
45 mm

Häkchen Hooklets



Wagener
14.0 cm



Fig. 1
12E-301.01



Fig. 2
12E-301.02



Fig. 3
12E-301.03



Fig. 4
12E-301.04



Day
16.0 cm



Fig. 1
12E-305.01



Fig. 2
12E-305.02



13E-003/005

Fig.	
1	13E-003
2	13E-004
3	13E-005

13E-003/005 Wiener Nasenspekula
Fig. 1 – 3

Vienna Nasal Specula
size 1 – 3



1/2
13E-006/010

Fig.	mm	
1	35	13E-006
2	50	13E-007
3	65	13E-008
4	75	13E-009
5	90	13E-010

13E-006/010 Killian Nasenspekula
Fig. 1 – 5

Killian Nasal Specula
size 1 – 5

13E-011/013 Hartmann Nasenspekula,
Fig. 1 – 3

Hartmann Nasal Specula,
size 1 – 3



13E-011/013

Fig.	mm	
1	28	13E-011
2	30	13E-012
3	32	13E-013

13E-014/016 Hartmann-Halle Nasenspekula, Fig. 1 – 3

Hartmann-Halle Nasal
Specula, size 1 – 3

13E-017 Tieck-Halle Nasenspekula,
für Kinder, 13,5 cm

Tieck-Halle Nasal Specula,
for children, 5 $\frac{1}{4}$ "



13E-014/016

Fig.	mm	
1	25	13E-014
2	29	13E-015
3	33	13E-016



13E-017



13E-020



13E-021



13E-022



13E-023/025

φ mm	
2,0	13E-023
2,5	13E-024
3,0	13E-025



13E-026

13E-020

Eicklen-Killian Kieferhöhlenspülkanülen mit Schlaucholive, φ 3 mm

Eicklen-Killian Antrum Wash Cannulas, with tubing connector, φ 3 mm

13E-021

Eicklen-Killian Kieferhöhlenspülkanülen, mit 2. Schlaucholive, φ 3 mm

Eicklen-Killian Antrum Wash Cannulas, with second tubing connector, φ 3 mm

13E-022

Killian Stirnhöhleenspülkanüle, biegsam, φ 1,5 mm

Killian, for frontal sinus, malleable, φ 1,5 mm

13E-023/025

Hartmann Kieferhöhlenspülkanüle, S-förmig

Hartmann Antrum Wash Cannulas, S-shape

13E-026

Fish Nasensonde, 14,0 cm

Fish Antrum Probe, 5 1/2 "

13E-027/032 Hartmann Kieferhöhlen-
spülkanüle, Fig. 1 und 2

Hartmann Antrum Wash
Cannulas, size 1 and 2

13E-037 Hartmann Polypenzange,
20,0 cm

Hartmann Nasal Polypus
Forceps, 8"

Fig. 1	φ mm	Fig. 2
13E-027	2,0	13E-030
13E-028	2,5	13E-031
13E-029	3,0	13E-032

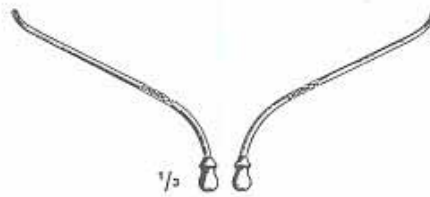

13E-027/032

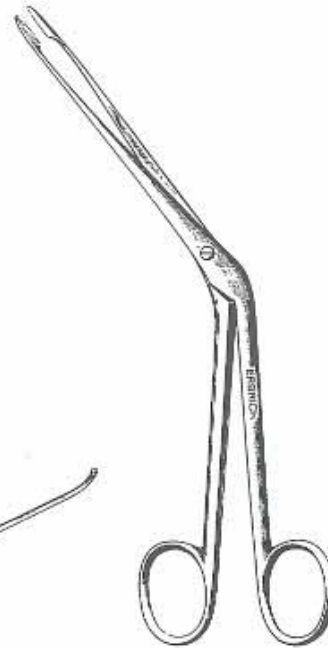

13E-037

13E-043 Asch Septumrichtzange,
23,0 cm

Asch Septum Straightening
Forceps, 9"

13E-044 Walsham Septumrichtzange,
23,0 cm

Walsham Septum
Straightening Forceps, 9"



13E-043



13E-044

RHINOLOGIE®
RHINOLOGY

Nasen-Sägen
Nasal Saws



Joseph
17 cm
13E-067



Joseph
17 cm
13E-068

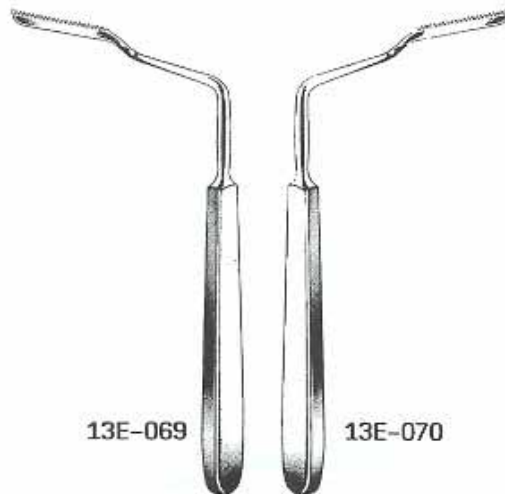

13E-069

13E-070





Joseph
17 cm

RHINOLOGIE
RHINOLOGY

Scharfe Nasenzangen
Nasal Cutting Forceps





Hajek

-  13E-070.01
2,2 mm
-  13E-070.02
2,6 mm
-  13E-070.03
3,0 mm
-  13E-070.04
3,4 mm



Struycken

-  13E-074.01
-  13E-074.02



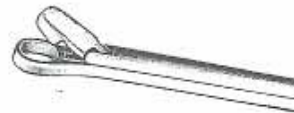

Myles

-  13E-076.01
-  13E-076.02
-  13E-076.03





Grünwald

-  13E-078.01
-  13E-078.02
-  13E-078.03



Schmeden

-  13E-082.01
-  13E-082.02
-  13E-082.03



Grünwald

-  13E-080.01

RHINOLOGIE
RHINOLOGY

Scharfe Nasenzangen
Nasal Cutting Forceps

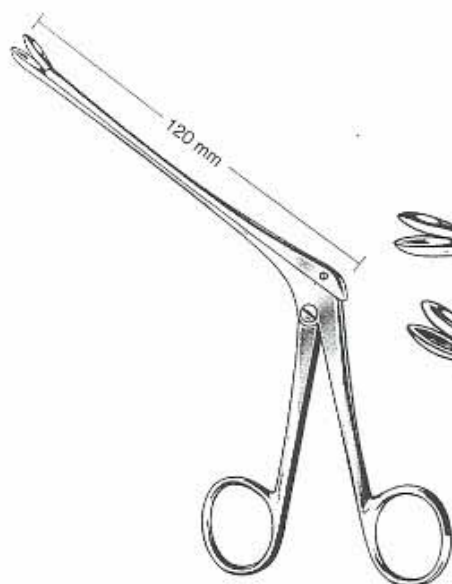

Weil-Blakesley

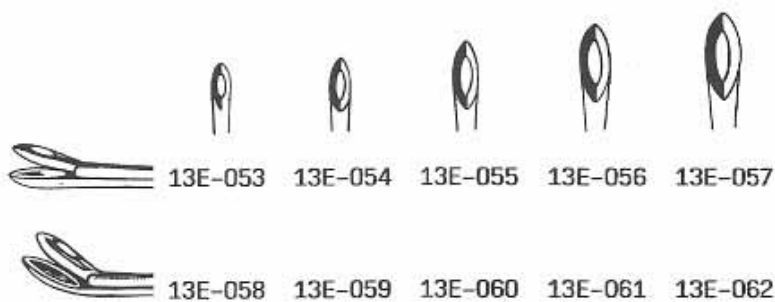

Hartmann

- 5 mm 13E-063
- 7 mm 13E-064
- 9 mm 13E-065
- 11 mm 13E-066



14E-001



14E-002

14E-001 Young Zungenzange, mit Gummibacken, 17,0 cm

Young Tongue Holding Forceps, with soft rubber jaws, 6³/₄"

14E-002 Collin Zungenzange, 16,0 cm

Collin Tongue Holding Forceps, 6¹/₄"

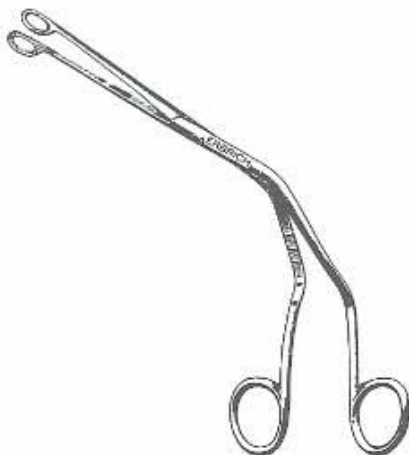

14E-007/008



14E-007



14E-008

14E-007 Magill Katheter-Einführungszange, für Kinder, 20,0 cm

Magill Catheter Introducing Forceps, for children, 8"

14E-008 Magill Katheter-Einführungszange, für Erwachsene, 25,0 cm

Magill Catheter Introducing Forceps, for adults, 10"

MUND UND ZUNGE ORAL INSTRUMENTS

Mundsperrer Mouth Gags

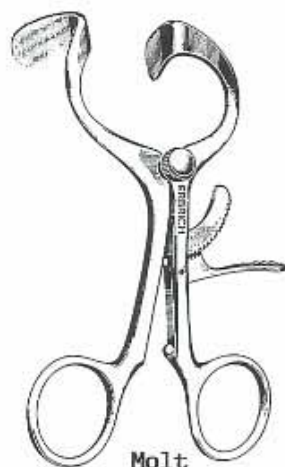

Molt

11 cm 14E-014
14 cm 14E-015



Heister
13 cm

14E-016

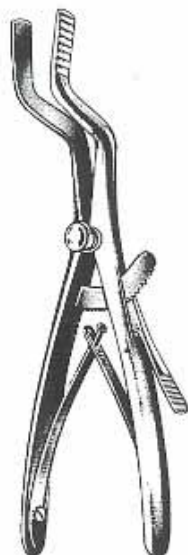

Roser-König

16 cm 14E-040.16
19 cm 14E-040.19

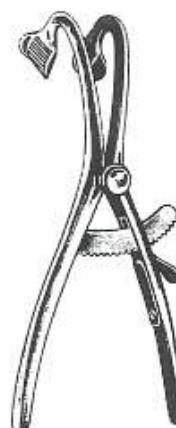

Denhart
12 cm

14E-041.12

MUND UND ZUNGE
ORAL INSTRUMENTS

Mundsperrer
Mouth Gags



Jennings

- 9,0 cm 14E-017
- 11,0 cm 14E-018
- 13,0 cm 14E-019
- 15,0 cm 14E-020

Sperrer allein
Gag only
14E-035.10

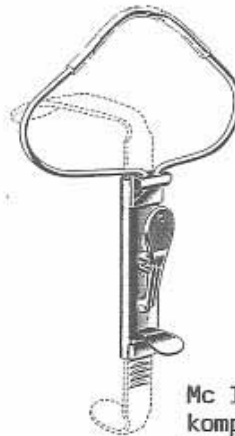

Mc Ivor
komplett
complete
14E-035.00

Fig. 1
23 x 70 mm
14E-035.01

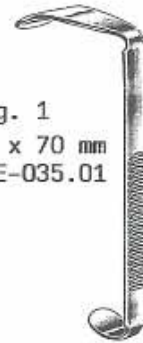

Fig. 2
25 x 86 mm
14E-035.02

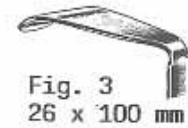

Fig. 3
26 x 100 mm
14E-035.03

Sperrer allein
Gag only
14E-042



Davis-Boyle
komplett
complete
14E-041

Fig. 1
21x26 mm
14E-043

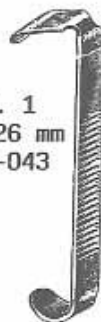

Fig. 2
23x65 mm
14E-044



Fig. 3
24x80 mm
14E-045



Fig. 4
25x93 mm
14E-046

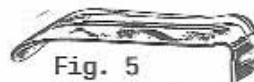

Fig. 5
26x108 mm
14E-047

TÖNSILLEN
TONSILS

Tonsillenschnürer
Tonsil Snares



Eves
28 cm
15E-001



Eves
28 cm
15E-002



Bruenings
28 cm
15E-003

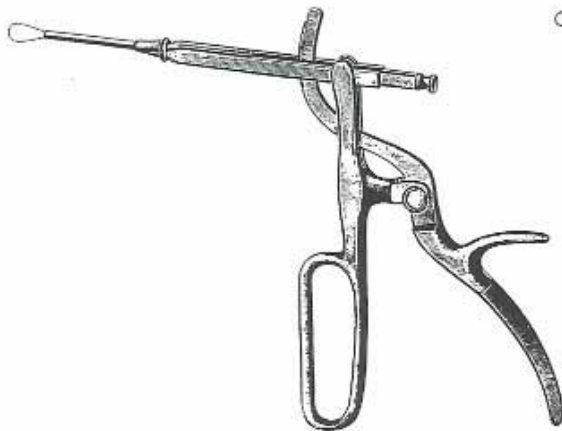

Tyding
15E-004

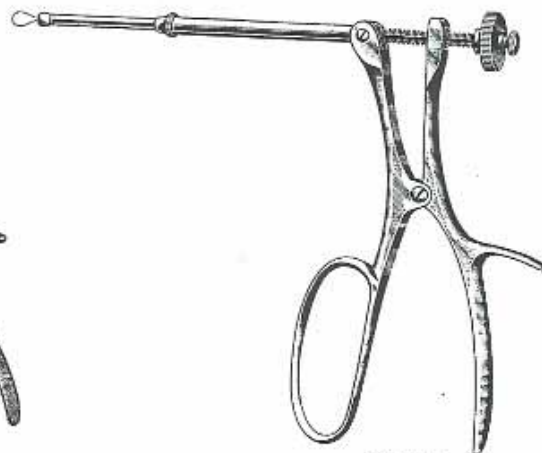

Brown
15E-007

TONSILLEN
TONSILS

Tonsillen-Klemmenzangen
Tonsil Haemostatic Forceps

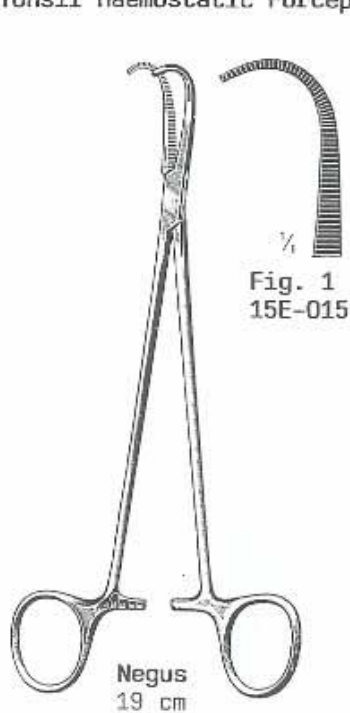

Fig. 1
15E-015



Fig. 2
15E-016



cm White
18 15E-037.18
23 15E-037.23

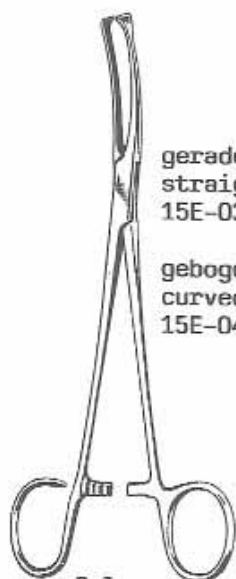

Colver
19 cm

gerade
straight
15E-039.19

gebogen
curved
15E-040.19



Blohmke
20 cm
15E-042.20

TONSILLEN
TONSILS

Ohr Polypenschnürer
Ear Polypus Snares



16 cm Krause
15E-022



16 cm Krause-Voss
15E-023

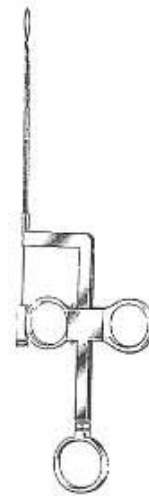

17 cm Lange-Wilde
15E-024

Nasen Polypenschnürer
Nasal Polypus Snares

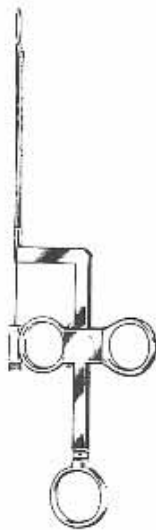

24 cm Lange-Wilde
15E-025



22 cm Krause
15E-026

mit 2 Aufsätzen
with 2 cannulas



26 cm Krause-Voss
15E-027

TONSILLEN
TONSILS

Tonsillenzangen
Tonsil Punch Forceps

ϕ mm	
13	15E-029
15	15E-030
17	15E-031

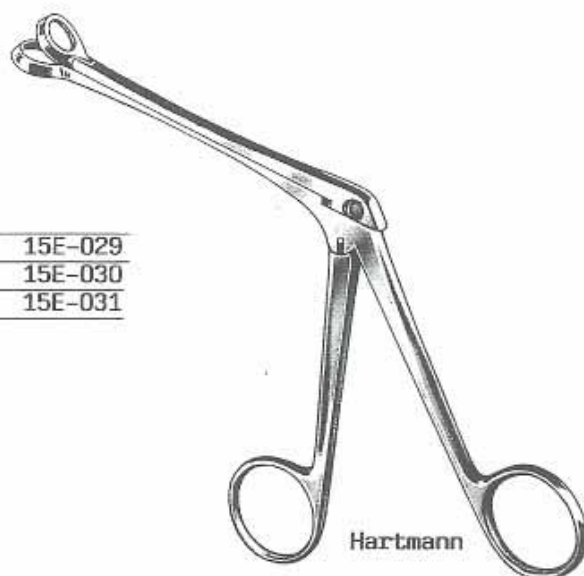

Hartmann

Tonsillen-Klemmzangen
Tonsil Haemostatic Forceps

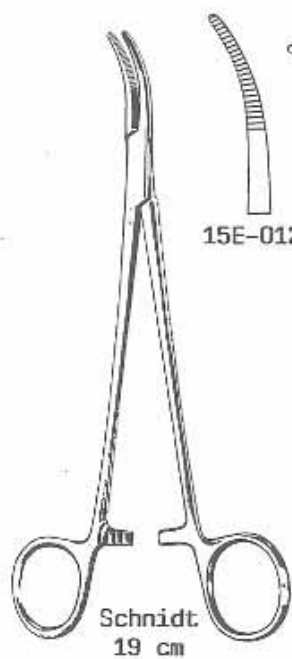

15E-012

15E-014

Schnidt
19 cm



15E-011

15E-013

Schnidt
19 cm

Tonsillen-Kanülen
Tonsil Needles



15E-100.01
Luer-Lock
Ø 0.8 x 75 + 25 mm



15E-100.02
Luer-Lock
Ø 0.8 x 75 + 25 mm, 45°



15E-100.03
Luer-Lock
Ø 0.8 x 75 + 25 mm, 90°

LARYNGOSKOPIE
LARYNGOSCOPY

Laryngoscope
Laryngoscopes

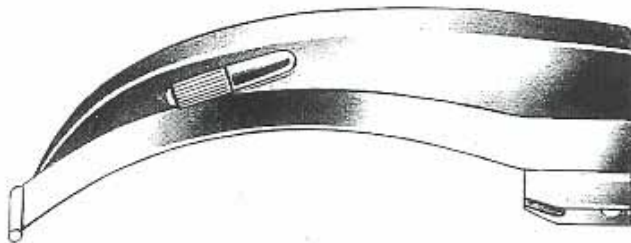

Laryngoskopie-Spatel nach McIntosh
McIntosh Laryngoscope Blades

Fig.	Nutzlänge working length	
0	75 mm	25E-012.00
1	90 mm	25E-012.01
2	110 mm	25E-012.02
3	130 mm	25E-012.03
4	150 mm	25E-012.04



für Spatel Fig. 0
for blades Fig. 0
25E-020.00



für Spatel Fig. 1-4
for blades Fig. 1-4
25E-020.01



Batteriegriff, für
konventionelle
Batterien

Battery Handle,
for conventional
batteries

25E-017.30
ø 30 mm



Batteriegriff, für
konventionelle
Batterien

Battery Handle,
for conventional
batteries

25E-017.18
ø 18 mm

Mit Trafoanschluß

With transformer connection

25E-016.30



Satz NC-Akku 1,8 V, aufladbar
über Transformator

Set NC-Accumulator 1,8 V,
rechargeable from transformer

25E-019.18

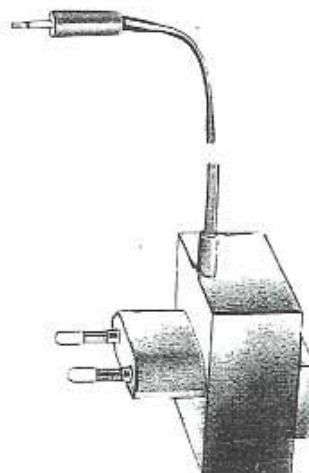

Transformator
Transformer

Transformator 220 Volt mit 1,4 m langen
Kabel. Transformator 110 Volt mit ameri-
kanischem Netzanschluß. Bei eventuellem
Fehlen oder Ausfallen von Batterien und
Akkus, direkter Netzanschluß über Trans-
formator möglich.

Transformer 220 Volt with cable 1,4 m long.
Transformer 110 Volt with american
connection. If batteries and accus are not
available or out of order, direct mains
connection use via transformer is possible.

220 V 25E-018.01
110 V 25E-018.02

LARYNGOSKOPIE
LARYNGOSCOPY

Laryngoskope
Laryngoscopes



McIntosh

25E-011.03 Satz in Etui, mit 3 Spatel, bestehend aus:

Set in case, with 3 blades, consisting of:

25E-017.30

25E-012.01

25E-012.02

25E-012.03

25E-011.04 Satz in Etui, mit 4 Spatel, bestehend aus:

Set in case, with 4 blades, consisting of:

25E-017.30

25E-012.01

25E-012.02

25E-012.03

25E-012.04

Baby-Mc-Intosh

25E-011.23 Satz in Etui, mit 3 Spatel, bestehend aus:

Set in case, with 3 blades, consisting of:

25E-017.30

25E-012.00

25E-012.01

25E-012.02

LARYNGOSKOPIE
LARYNGOSCOPY

Kaltlicht-Laryngoskope mit
Halogen und Fiber-Optik

Fiber optic laryngoscopes with
Halogen and Fiber Optic Illumination

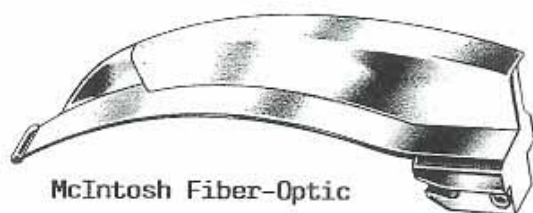

McIntosh Fiber-Optic

Laryngoskopie-Spatel nach McIntosh
McIntosh Laryngoscope Blades

Fig.	Nutzlänge working length	
0	75 mm	25E-030.00
1	90 mm	25E-030.01
2	110 mm	25E-030.02
3	130 mm	25E-030.03
4	150 mm	25E-030.04



∅ 30 mm

Kaltlicht-Batteriegriff,
für konventionelle Batterien
Fiber-Optik Battery Handle,
for conventional batteries
25E-037.30

Mit 4,5 V Halogenlampe

With 4,5 V Halogen Lamp
25E-037.34

Mit Trafoanschluß
With transformer connection
25E-036.30

+ mit 4,5 V Halogenlampe
+ with 4,5 V Halogen Lamp
25E-036.34



Halogenlampe 2,5 V
Halogen Lamp 2,5 V
25E-020.25



Halogenlampe 4,5 V
Halogen Lamp 4,5 V
25E-020.45



Satz NC-Akku, aufladbar
über Transformator, 1,8 V
Set NC-Accumulator, 1,8 V,
rechargeable from transformer
25E-019.18

Satz NC-Akku, aufladbar
über Transformator, 4,5 V
Set NC-Akkumulator, 4,5 V,
rechargeable from transformer
25E-019.45

LARYNGOSKOPIE LARYNGOSCOPY

Kaltlicht-Laryngoskope mit
Halogen und Fiber-Optik

Fiber optic laryngoscopes with
Halogen and Fiber Optic Illumination



McIntosh Fiber-Optik

25E-031.03 Satz in Etui, mit 3 Spatel,
bestehend aus:

Set in case, with 3 blades,
consisting of:

25E-037.30

25E-030.02

25E-030.03

25E-030.04

25E-031.04 Satz in Etui, mit 4 Spatel,
bestehend aus:

Set in case, with 4 blades,
consisting of:

25E-037.30

25E-030.01

25E-030.02

25E-030.03

25E-030.04

LARYNGOSKOPIE
LARYNGOSCOPY

Laryngoskope
Laryngoscopes



Laryngoskopie-Spatel nach Miller
Miller Laryngoscope Blades

Fig.	Nutzlänge working length	
0	75 mm	25E-035.00
1	100 mm	25E-035.01
2	155 mm	25E-035.02
3	195 mm	25E-035.03
4	205 mm	25E-035.04

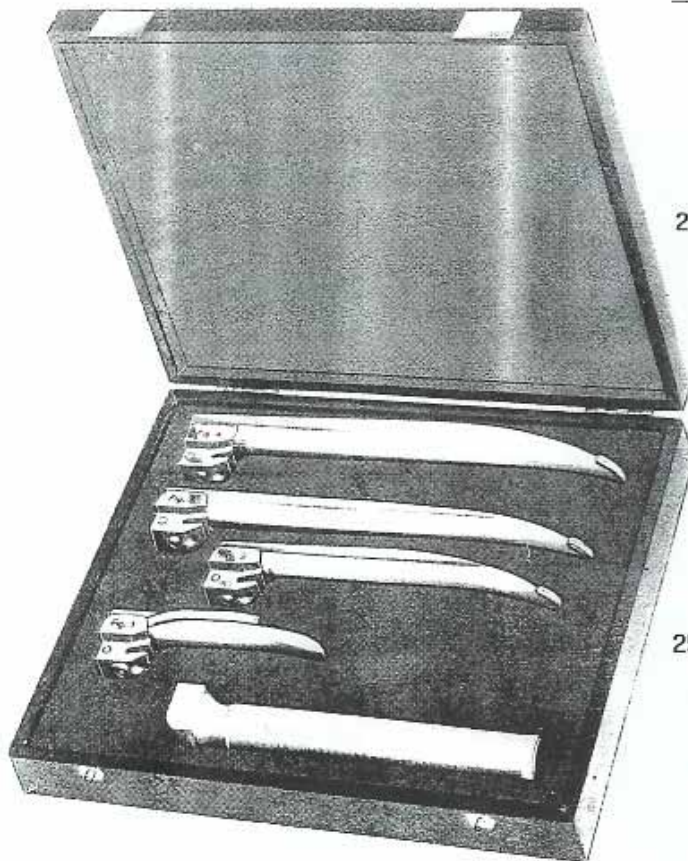

25E-038.03 Satz in Etui, mit 3 Spatel,
bestehend aus:

Set in case, with 3 blades,
consisting of:

25E-017.18
25E-035.02
25E-035.03
25E-035.04

25E-038.04 Satz in Etui, mit 4 Spatel,
bestehend aus:

Set in case, with 4 blades,
consisting of:

25E-017.18
25E-035.01
25E-035.02
25E-035.03
25E-035.04

Miller



25E-020.00 Für Spatel 0-3
For blades 0-3



25E-020.01 Für Spatel 4
For blades 4

LARYNGOSKOPIE
LARYNGOSCOPY

Laryngoskope
Laryngoscopes



Laryngoskopie-Spatel nach Wisconsin-Foregger
Wisconsin-Foregger Laryngoscope Blades

Fig.	Nutzlänge working length	
0	90 mm	25E-040.00
1	115 mm	25E-040.01
2	130 mm	25E-040.02
3	160 mm	25E-040.03
4	190 mm	25E-040.04



Wisconsin-Foregger

25E-043.03 Satz in Etui, mit 3 Spatel,
bestehend aus:
Set in case, with 3 blades,
consisting of:
25E-016.30
25E-040.02
25E-040.03
25E-040.04

25E-043.04 Satz in Etui, mit 4 Spatel,
bestehend aus:
Set in case, with 4 blades,
consisting of:
25E-016.30
25E-040.01
25E-040.02
25E-040.03
25E-040.04

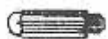
 25E-020.00 Für Spatel 0-1
For blades 0-1

 25E-020.01 Für Spatel 2-4
For blades 2-4

LARYNGOSKOPIE
LARYNGOSCOPY

Kaltlicht-Laryngoskope mit
Halogen und Fiber-Optik
Fiber optic laryngoscopes with
Halogen and Fiber Optic Illumination

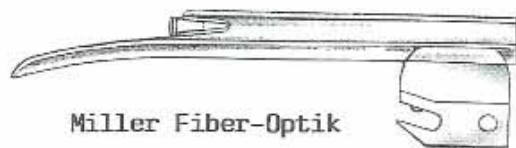

Miller Fiber-Optik

Laryngoskopie-Spatel nach Miller
Miller Laryngoscope Blades

Fig.	Nutzlänge working length	
0	75 mm	25E-036.00
1	100 mm	25E-036.01
2	155 mm	25E-036.02
3	195 mm	25E-036.03
4	205 mm	25E-036.04

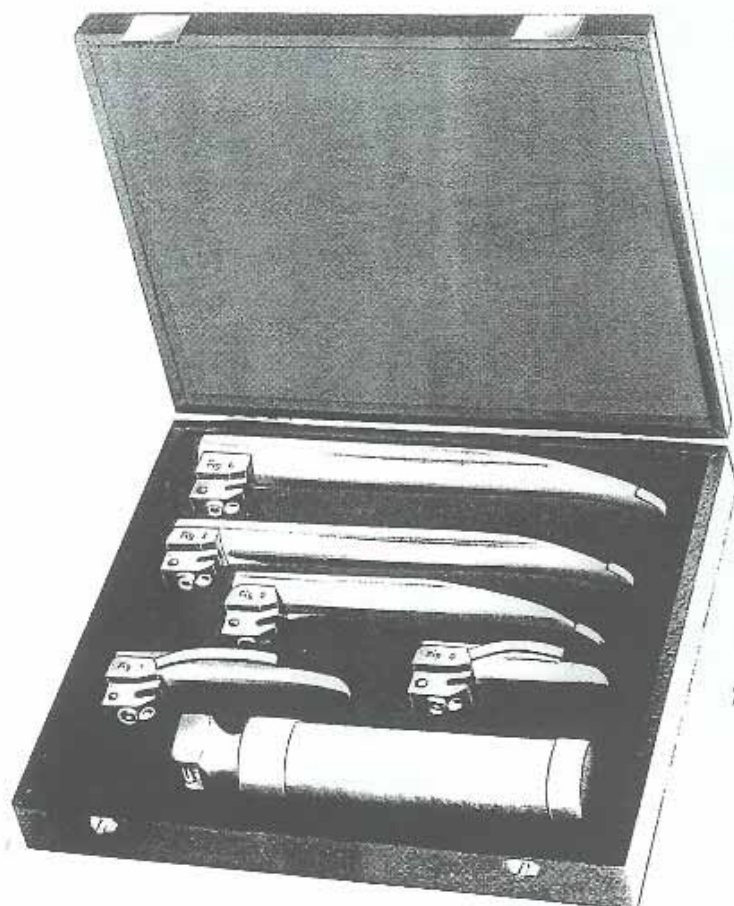

Miller Fiber-Optik

25E-039.03 Satz in Etui, mit 3 Spatel,
bestehend aus:

Set in case, with 3 Blades,
consisting of:

25E-037.30
25E-036.02
25E-036.03
25E-036.04

25E-039.04 Satz in Etui, mit 4 Spatel,
bestehend aus:

Set in case, with 4 blades,
consisting of:

25E-037.30
25E-036.01
25E-036.02
25E-036.03
25E-036.04

25E-039.05 Satz in Etui, mit 5 Spatel,
bestehend aus:

Set in case, with 5 blades,
consisting of:

25E-037.30
25E-036.00
25E-036.01
25E-036.02
25E-036.03
25E-036.04