

Wundhaken Retractors



Guthrie, 16.0 cm
scharf / sharp



Fig. 1
01E-605.01



Fig. 2
01E-605.02



Iterson
16.0 cm



scharf / sharp
01E-608.16



stumpf / blunt
01E-609.16



Senn-Green
15.0 cm



10 x 6 mm
01E-622.10



20 x 6 mm
01E-622.20

WUND- UND HAUTHÄCKHEN
WOUND AND SKIN RETRACTORS



01E-606.01

Joseph 15,5 cm



Joseph 16,5 cm



2 mm
01E-606.02



5 mm
01E-606.05



7 mm
01E-606.07



10 mm
01E-606.10

ALLGEMEINE CHIRURGIE
GENERAL SURGERY

Wundhaken
Retractors

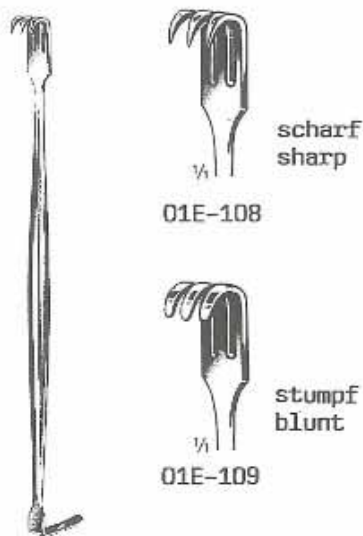
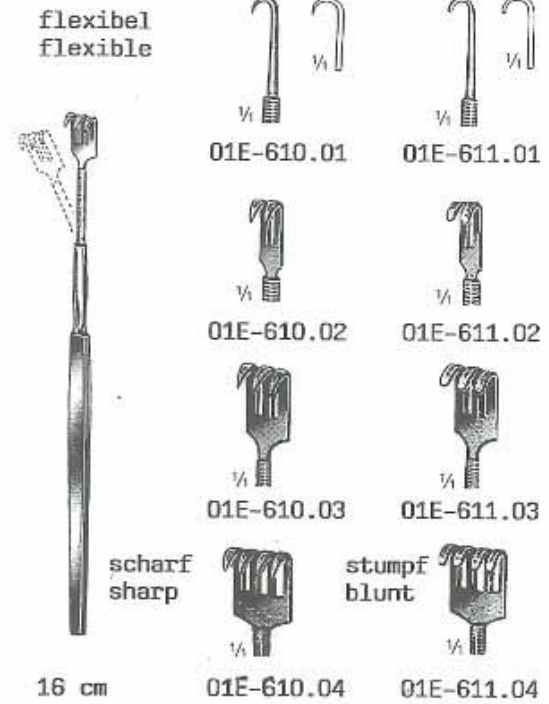
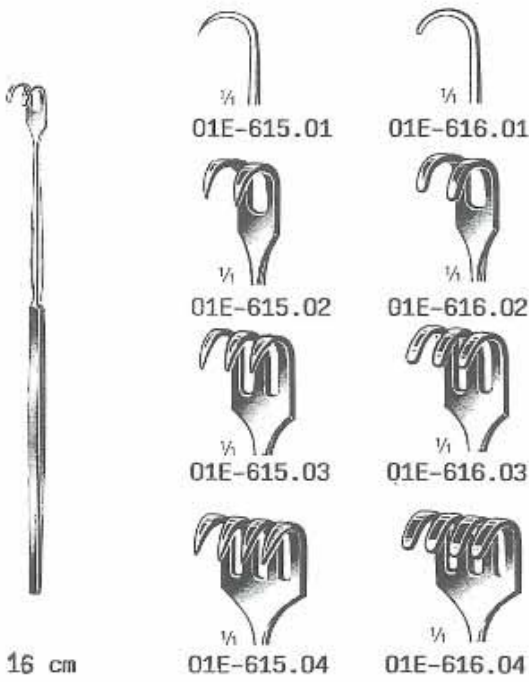

Senn-Miller
16 cm



Mini-Langenbeck
16 cm

ALLGEMEINE CHIRURGIE
GENERAL SURGERY

Wundhaken
Retractors



Volkman

scharf
sharp



01E-641.01



01E-641.02



01E-641.03



01E-641.04



01E-641.06

stumpf
blunt



01E-642.01



01E-642.02



01E-642.03



01E-642.04



01E-642.06

halbscharf
semi-sharp



01E-643.01



01E-643.02



01E-643.03



01E-643.04



01E-643.06



| Langenbeck 22 cm | | mm | Langenbeck 21 cm | |
|---------------------|---------|----|---------------------|--|
| 01E-660.01 | 30 x 11 | | 01E-661.01 | |
| 01E-660.02 | 30 x 14 | | 01E-661.02 | |
| 01E-660.03 | 30 x 16 | | 01E-661.03 | |
| 01E-660.04 | 40 x 11 | | 01E-661.04 | |
| 01E-660.05 | 50 x 11 | | 01E-661.05 | |
| | 60 x 20 | | 01E-661.06 | |
| | 85 x 15 | | 01E-661.07 | |



ALLGEMEINE CHIRURGIE
GENERAL SURGERY

Wundhaken
Retractors



Desmarres
16 cm



01E-628.12
12 mm



01E-628.16
16 mm



01E-628.14
14 mm



01E-628.18
18 mm



Farabeuf



Satz
Set

01E-105
12 cm

01E-100
15 cm



Roux

Satz
Set
01E-410.00

Fig.1 14 cm
01E-410.01

Fig.2 15 cm
01E-410.02

Fig.3 17 cm
01E-410.03



Baby-Roux
01E-410.13
13 cm



01E-668.01
19 x 12 mm

01E-668.02
21 x 15 mm

Kocher
19 cm

ALLGEMEINE CHIRURGIE
GENERAL SURGERY

Wundhaken, Wundsperrer
Retractors



Kocher-Langenbeck
21,0 cm

| mm | |
|---------|------------|
| 25 x 6 | 01E-664.01 |
| 35 x 8 | 01E-664.02 |
| 35 x 11 | 01E-664.03 |
| 35 x 15 | 01E-664.04 |
| 40 x 11 | 01E-664.05 |
| 55 x 11 | 01E-664.06 |
| 70 x 14 | 01E-664.07 |
| 80 x 12 | 01E-664.08 |
| 80 x 16 | 01E-664.09 |

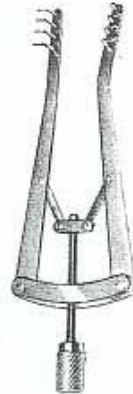

Alm

| | scharf sharp | stumpf blunt |
|-------|-----------------|-----------------|
| 7 cm | 01E-735.07 | 01E-736.07 |
| 10 cm | 01E-735.10 | 01E-736.10 |



01E-750.10
10 cm

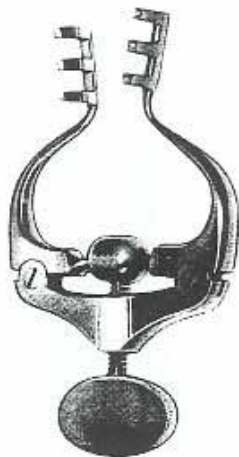

Jansen

| cm | scharf sharp | stumpf blunt |
|------|-----------------|-----------------|
| 10,5 | 01E-752.10 | 01E-753.10 |
| 13,0 | | |
| 16,5 | | |

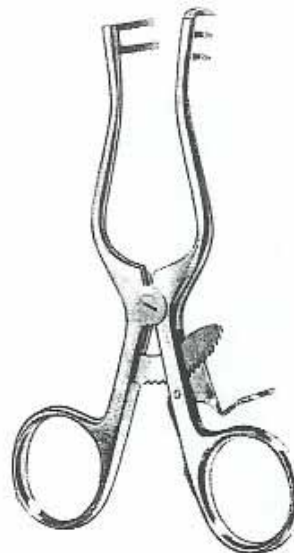

Weitlaner

| cm | scharf sharp | stumpf blunt |
|----|-----------------|-----------------|
| | 01E-428 | 01E-429 |

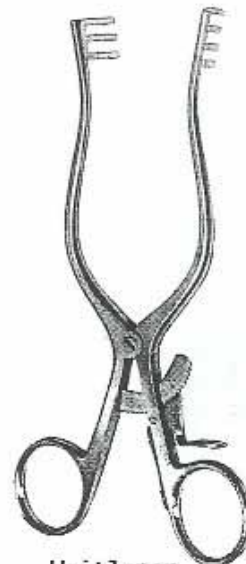

Weitlaner

| cm | scharf sharp | stumpf blunt |
|----|-----------------|-----------------|
| | 01E-110 | 01E-111 |
| | 01E-480 | 01E-481 |

ALLGEMEINE CHIRURGIE
GENERAL SURGERY

Wundsperrerr
Retractors

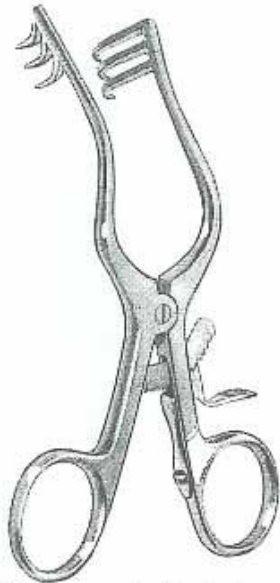

Weitlaner-Wollstein
scharf stumpf
cm sharp blunt
13 01E-770.13 01E-771.13



Mollison
01E-777.15
15 cm



Plester
scharf stumpf
cm sharp blunt
13 01E-772.13 01E-773.13

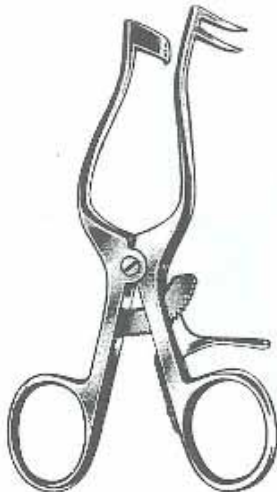

Plester
01E-774.11
11 cm

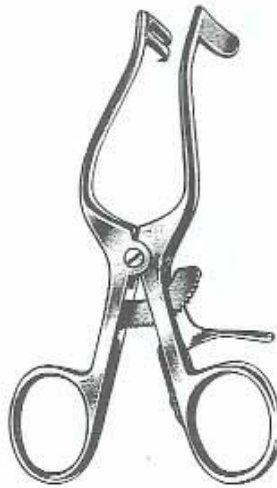

Plester
01E-775.11
11 cm

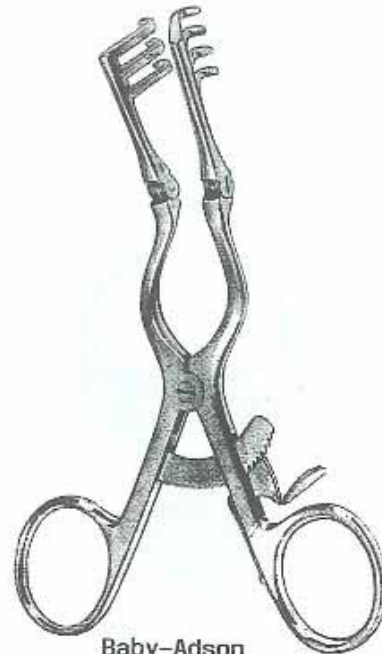

Baby-Adson
scharf stumpf
cm sharp blunt
13,0 01E-785.13 01E-786.13
16,5 01E-785.16 01E-786.16

G O S S E T

Bauchdeckenhalter
Abdominal Retractors

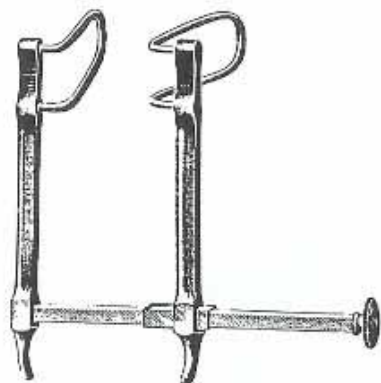

01E-112 40 mm x 90 mm
01E-113 63 mm x 160 mm

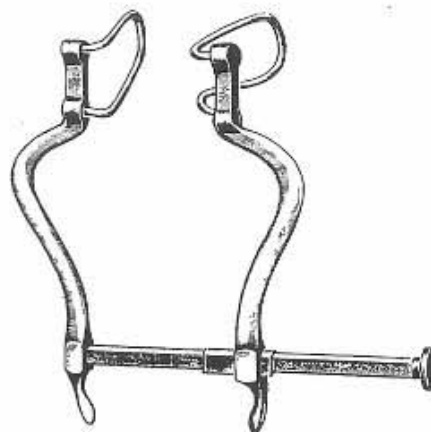

01E-270 60 mm x 140 mm

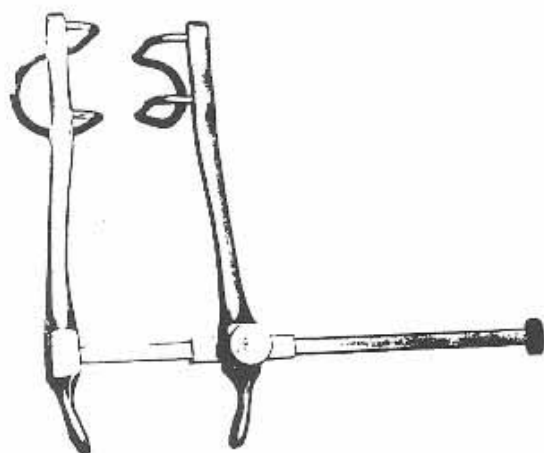

01E-271 40 mm x 90 mm
mit Feststellschraube
with fixing screw

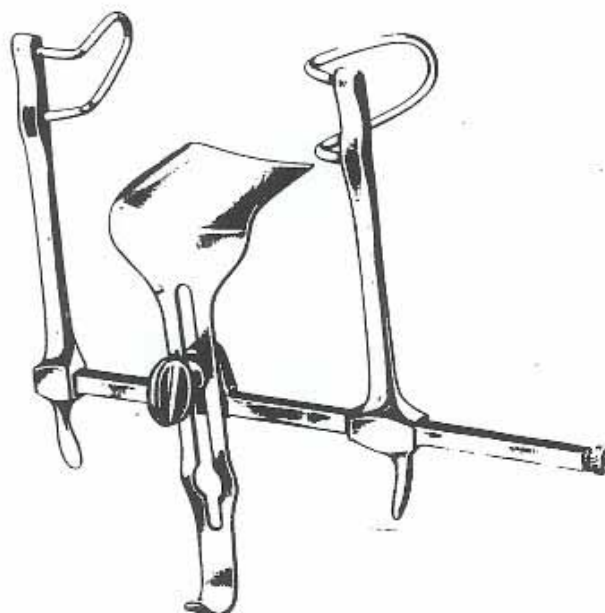

01E-430 63 mm x 160 mm
mit Mittelblatt
with centre blade

BALFOUR

Bauchdeckenhalter
Abdominal Retractors

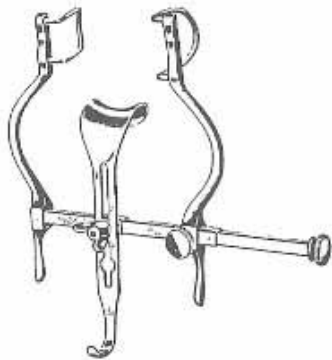

| | | |
|---------|----------------|-------|
| 01E-431 | Spreizweite | 90 mm |
| | Blade opening | 90 mm |
| | Valventiefe | 27 mm |
| | Deep of Valves | 27 mm |

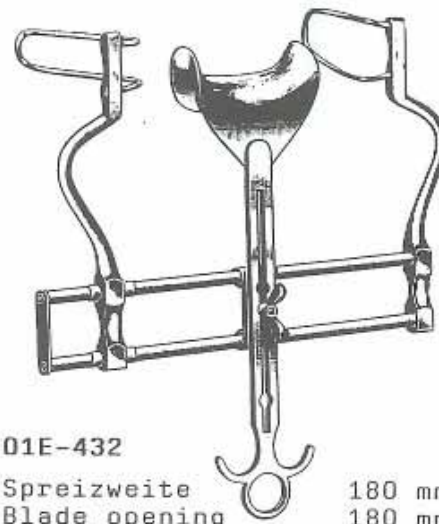

| | | |
|---------|----------------|--------|
| 01E-432 | Spreizweite | 180 mm |
| | Blade opening | 180 mm |
| | Valventiefe | 63 mm |
| | Deep of Valves | 63 mm |

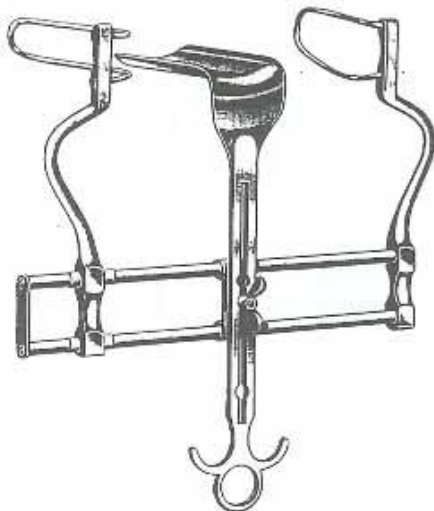

| | | |
|---------|----------------|--------|
| 01E-433 | Spreizweite | 200 mm |
| | Blade opening | 200 mm |
| | Valventiefe | 100 mm |
| | Deep of Valves | 100 mm |

01E-436
Mittelblatt allein, 24 mm x 20 mm
für 01E-431
Centre blade only, 24 mm x 20 mm
for 01E-431

01E-437
Mittelblatt allein, 45 mm x 80 mm
für 01E-432
Centre blade only, 45 mm x 80 mm
for 01E-432

01E-438
Mittelblatt allein, 70 mm x 100 mm
für 01E-433
Centre blade only, 70 mm x 100 mm
for 01E-433

BALFOUR

Bauchdeckenhalter
Abdominal Retractors

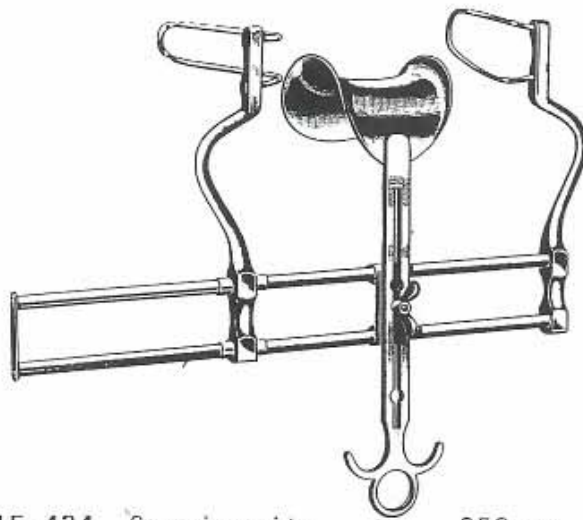

| | | |
|---------|----------------|--------|
| 01E-434 | Spreizweite | 250 mm |
| | Blade opening | 250 mm |
| | Valventiefe | 100 mm |
| | Deep of Valves | 100 mm |

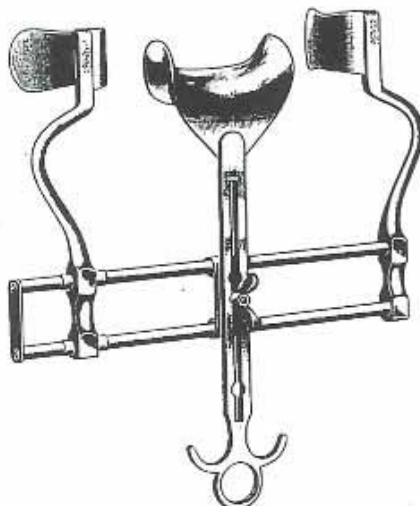

| | | |
|---------|----------------|--------|
| 01E-435 | Spreizweite | 180 mm |
| | Blade opening | 180 mm |
| | Valventiefe | 70 mm |
| | Deep of Valves | 70 mm |

01E-439
Mittelblatt allein, 70 mm x 85 mm
für 01E-434
Centre blade only, 70 mm x 65 mm
for 01E-434

01E-437
Mittelblatt allein, 45 mm x 80 mm
für 01E-435
Centre blade only, 45 mm x 80 mm
for 01E-435

Wundhaken
Retractors



Graefe
16.0 cm



scharf
sharp
01E-600.16



stumpf
blunt
01E-601.16



Emmet, 22.0 cm
scharf / sharp



Fig. 1
01E-602.01



Fig. 2
01E-601.02



Fig. 3
01E-601.03



Kilner, 15.0 cm
scharf / sharp
01E-603.15



Gillies, 18.0 cm
scharf / sharp



Fig. 1
01E-604.01



Fig. 2
01E-604.02